

KBB2E250/56 BACKWARD CURVED IMPELLER BLOWER



KBB2E250/56

STANDARD FEATURES

Low noise level
953 CFM capacity
Available in 115 and 230 VAC
Compact size
Precision balanced
External rotor design
Precision ball-bearing motors
UL and CE approved

TECHNICAL DATA*

Model	CFM@ 0" S.P.	Cutoff S.P.	Amps	Watts
KBB2E250/56	953	2.9	2.17	256

*60 Hz. operation.

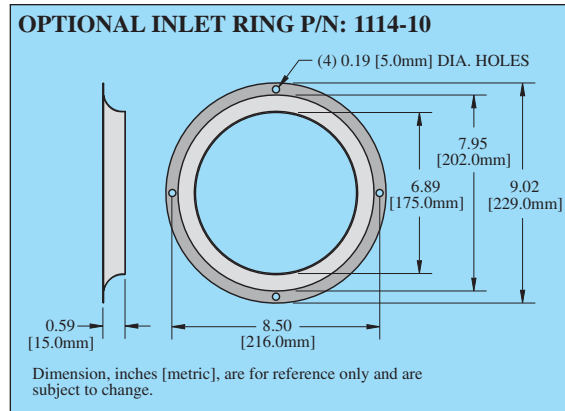
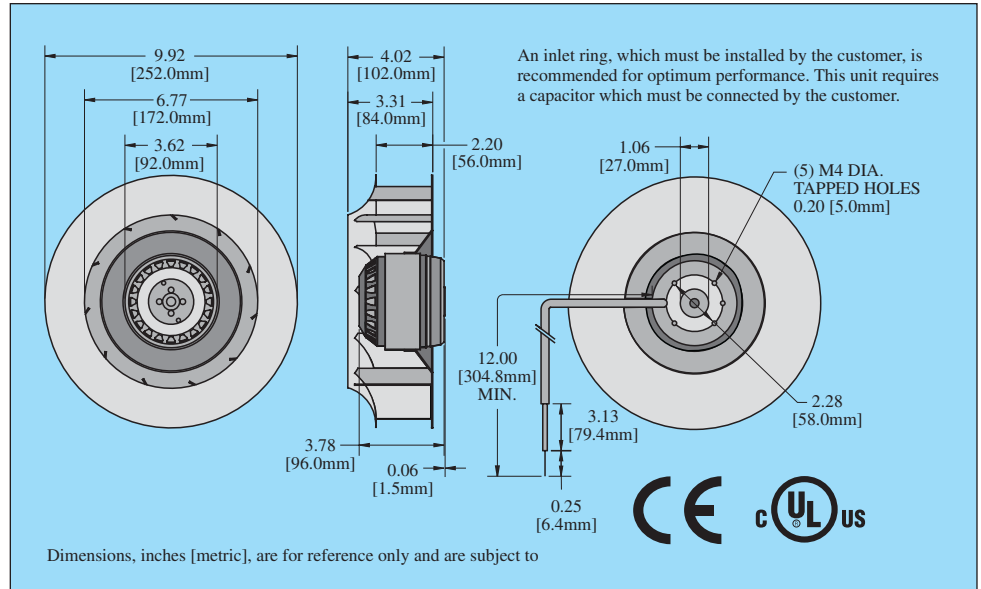
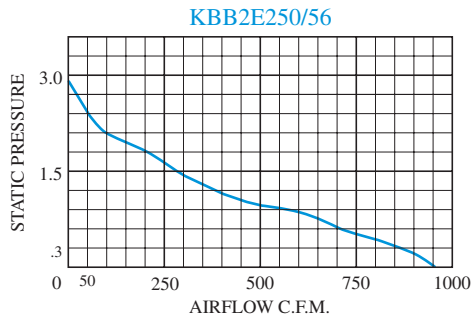

HOW TO ORDER

Specify model number:
115 VAC: KBB2E250/56
230 VAC: K2BB2E250/56

For assistance in model selection, refer to the Blower and Fan Selection Guides, or contact **KOOLTRONIC**.

CALL 1-800-321-KOOL (5665)
or FAX 609-466-1114

POPULAR MODELS ARE STOCKED AND READY TO SHIP

Airflow vs. static pressure curves are shown for 60 Hz input.

CONVERSION FACTORS

Multiply airflow in cubic feet per minute (CFM) by:

- 1.7 to obtain airflow in cubic meters per hour (m³/hr.)
- 0.47 to obtain airflow in liters per second (L/S)

Multiply static pressure in inches of water ("H₂O) by:

- 25.4 to obtain static pressure in millimeters of water (mm H₂O)
- 249 to obtain static pressure in Pascals (Pa)

TYPICAL INSTALLATION

