

**MICRO-MINI
KA4C1.0MML
with Serial Numbers
D17A1203 and above**

**Keep This Manual
With Air Conditioner**

Find additional information on this model at kooltronic.com or use the Technical Documents QR code below.

Technical Documents



AIR CONDITIONER OPERATOR'S MANUAL

CAUTION

BEFORE INSTALLING AND USING THIS AIR CONDITIONER, IT IS IMPORTANT THAT THIS MANUAL BE READ AND UNDERSTOOD THOROUGHLY



**KOOLTRONIC, INC.
30 Pennington-Hopewell Road
Pennington, NJ 08534
609•466-3400
FAX: 609•466-1114
www.kooltronic.com**

TABLE OF CONTENTS

		Page
I.	Introduction	2
II.	Incoming Inspection	3
III.	Product Handling	3
IV.	Product Identification and Nameplate	4
V.	Principles of Operation	5 - 7
VI.	Pre-Installation Testing	8
VII.	Specific Model Data	9 - 12
	Mounting	
	Drawings and Dimensions	
	Technical Data	
	Major Component Replacements	
VIII.	Maintenance	13 - 14
IX.	Trouble Shooting	15
X.	Warranty	16

NOTE: Wiring Schematics are available on the specific model page of the Kooltronic website.

I. Introduction

Kooltronic Air Conditioners are designed to provide a cool, dehumidified environment for your electronic components. There are models to fit virtually all sizes and shapes of electronic enclosures, in capacities ranging from 1,000 to 30,000 BTU/H. Our "closed-loop" design also ensures that your components will not be exposed to hot, dirty operating conditions.

This Manual provides you with the necessary general information for properly installing and operating standard Kooltronic Air Conditioners. Technical data and mounting instructions

II. Incoming Inspection

Kooltronic Air Conditioners are designed, built and packaged to withstand the shock and vibration normally associated with shipment by common carriers. Occasionally improper handling during shipping causes damage. Such handling could include unbanding of palletized shipments, failing to respect "**This Side Up**" arrows, rough handling, falling off conveyors, excessive vibration, crushing, etc. Therefore, a thorough inspection should be done upon receipt of all shipments. Any carton tears, dents, scratches, loose articles or evidence of oil are signs of damage and should be noted on the Freight Bill. Cartons should be opened promptly and the units inspected for **CONCEALED DAMAGE**. Kooltronic Air Conditioners must be delivered in the proper mounting position to assure that damage to the compressor has not occurred during shipping. Any Kooltronic Air Conditioner that is delivered removed from the banded pallet, lying down or double stacked should be refused.

An immediate claim **MUST** be filed with the freight carrier and an inspection requested. Retain all packing materials. Kooltronic cannot assume responsibility for Consignee's failure to file a timely freight claim.

III. Product Handling:

- 1) Do not attempt to operate your Kooltronic Air Conditioner until you read and thoroughly understand this Manual. See section **VI PRE-INSTALLATION TESTING**.
- 2) Before operating the Kooltronic Air Conditioner be certain that it is placed in its correct mounting position. **These Air Conditioner are designed to operate in a vertical position only.** This placement must be done a minimum of 5 minutes prior to operating in order to allow the compressor oil to drain to the compressor sump area.

CAUTION

Kooltronic Air Conditioners must be operated in their proper mounting position. If attempts are made to operate a unit that is not in its designed mounting position, permanent compressor damage will occur. This action will void the warranty. To avoid compressor damage do not tip the unit more than 45° from its proper mounting position.



- 3) Before operating this unit, all electrical wiring must be checked to assure the proper connection to the correct power source. Minimum circuit ampacity should be at least 125% of the amperage found on the nameplate for the corresponding voltage. Do not exceed the maximum fuse size found on the nameplate.
- 4) We do not recommend that Air Conditioners be shipped to their final destination attached to an enclosure. In the event that the Air Conditioner needs to be shipped attached to an enclosure it is strongly recommended that proper support be provided for the Air Conditioner. Excessive vibration can occur if Air Conditioners are not properly supported when shipped on enclosures, increasing the potential for internal damage and voiding the warranty.
- 5) **PROCEDURE FOR PROPER PACKING AND SHIPMENT OF KOOLTRONIC AIR CONDITIONERS:**
 - Keep Air Conditioner in proper upright position indicated by arrow markers.
 - Pack Air Conditioner in an appropriate carton (preferably original carton if possible), with adequate internal protective packaging, making sure carton is marked and is kept in correct upright position.
 - For local, controlled transportation, strap carton to a secure part of truck to prevent falling or sliding, minimize vibration, etc.
 - For common carrier shipment, band unit(s) securely to a pallet. Unpalletted shipment risks severe damage which voids the warranty.

IV. Product Identification and Nameplate

Each Kooltronic Air Conditioner includes an identification nameplate. This nameplate provides:

- ① Model Number
- ② Serial Number
- ③ Electrical power characteristics
- ④ Maximum and minimum ambient operating temperatures
- ⑤ Cooling capacity
- ⑥ Type and amount of refrigerant required for recharging
- ⑦ Design Pressure
- ⑧ Maximum Fuse Size
- ⑨ Manufacturing Order Number
- ⑩ Filter Part Number
- ⑪ Underwriters Laboratories Inc. Listed or Recognized Marks and NEMA ratings

We recommend you copy this information from your unit.

		Air Conditioner			
MODEL NUMBER		SERIAL NUMBER			
①		②			
VOLTS	FREQ.	PH.	COOLING F.L.A.	AMBIENT TEMP. MIN.°F MAX.°F	
③	③	③	③	④	④
COOLING BTU		REFRIGERANT		Oz.	
⑤		⑥			
DESIGN PRESSURE P.S.I.G.		MAX. FUSE SIZE			
LOW	HIGH	⑧			
⑦	⑦	⑧			
		FILTER P/N			
		⑨			
		MFG. ORDER NO.			
		⑩			
					
				LISTED 84H7 SPECIAL PURPOSE AIR CONDITIONER	
				⑪	
SPECIAL PURPOSE AIR CONDITIONER NEMA/EEMAC/UL50 BY UNDERWRITERS LABORATORIES, INC. TYPE 12 INTERFACE TO THE ELECTRICAL ENCLOSURE ONLY NEMA/EEMAC/UL50 BY UNDERWRITERS LABORATORIES, INC. TYPE 1 SPECIAL PURPOSE AIR CONDITIONER EQUIPMENT COMPARTMENT ONLY SERVICE AIR FILTER REGULARLY ALLOW 5 MIN. BEFORE RESTARTING AFTER SHUTDOWN UNAUTHORIZED SERVICE OR MODIFICATION VIOLATES WARRANTY ALL MOTORS ARE THERMALLY PROTECTED					
MANUFACTURED BY: KOOLTRONIC, INC. PENNINGTON, NJ					
					

①②⑨ When ordering parts, specify the Model Number, Serial Number & MFG. Order Number.

③ Before operating, be sure that the power source matches these requirements.

④ Make sure that these parameters are met. Failure to do so may result in permanent damage to the unit.

⑥ Use of incorrect type or amount of refrigerant will adversely affect performance and may damage the unit.

V. Principles of Operation

Kooltronic Air Conditioners are required when the equipment operating temperature must be kept near or lower than the ambient room temperature, and/or the cabinet must be sealed from dust, fumes, oil, corrosives and other contaminants. These Air Conditioners utilize a "Closed-Loop Cooling System" to ensure optimum performance of the installed components.

Closed-Loop cooling seals the electronic enclosure from hostile elements in the environment. Two separate circulation systems are employed. The internal system cools and dehumidifies the air inside the cabinet, totally isolating the sensitive electronics and other components from the environment. The external system uses circulating ambient air or water to discharge the heat removed from the electronics. The heat is dissipated from the enclosure by means of the vapor compression refrigeration cycle. This takes place in a hermetically-sealed refrigeration system, utilizing either an air-cooled or water-cooled condenser heat exchanger. The warm air inside the enclosure is drawn through the evaporator coil where it is cooled, dehumidified and returned.

Any enclosure moisture accumulated on the evaporator coil is collected in the condensate tray and removed through the drain tube to the condensate evaporator. Condensate evaporates in the condensate evaporator and is released to the ambient air by the condenser impeller.

The heat removed through the evaporator coil is transferred by the compressed refrigerant to the condenser coil. Ambient air is then passed through the condenser coil, where it absorbs the heat and is then discharged to the environment.

When the Kooltronic Air Conditioner is properly sized it should operate constantly and maintain 75°F to 115°F enclosure temperature, depending on the ambient temperatures.

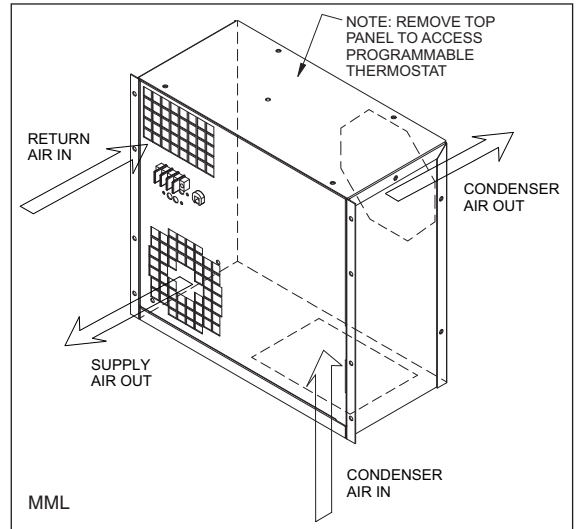

CONTROL ACTION

The evaporator blower operates continuously. The compressor is cycled on and off by the action from the factory preset programmable thermostat. A pressure switch controls the on/off action of the condenser blower.

The regulation is performed according to the temperature measured by the thermostat probe with a positive differential from the set point: if the temperature increases and reaches set point plus differential the compressor is started and then turned off when the temperature reaches the set point value again.

In case of fault in the thermostat probe the start and stop of the compressor are timed through preset parameters.

The programmable thermostat is located as shown in the upper right ISO illustration. **WARNING:** the programmable device is preprogrammed and set at the factory. In the event changes are needed the following instructions can be used.

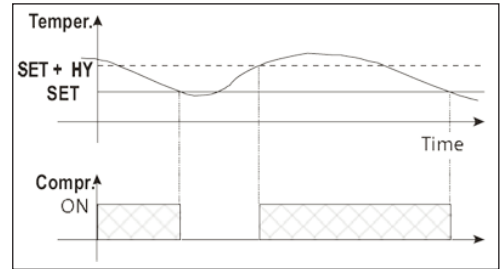

FRONT PANEL COMMANDS



KEY COMBINATIONS

- + To lock and unlock the keyboard.
- SET** + To return to the room temperature display.
- SET** + To enter programming mode.

- SET** - To display target set point; in programming mode it selects a parameter or confirms an operation.
- (**UP**) - To see the max. stored temperature; in programming mode it browses the parameter codes or increases the displayed value.
- (**DOWN**) - To see the min. stored temperature; in programming mode it browses the parameter codes or decreases the displayed value.
- To switch the instrument off, if onF = oFF.
- Not enabled.
- (**DEF**) - To start a manual defrost.

FRONT PANEL LED INDICATORS

LED Functions		
LED	MODE	FUNCTION
	ON	Compressor enabled
	Flashing	Anti-short cycle delay enabled
	ON	An alarm is occurring
	ON	Continuous cycle is running (not enabled)
	ON	Energy saving (not enabled)
°F	ON	Measurement unit
°F	Flashing	Programming phase

Principles of Operation (con't)

MAX AND MIN TEMPERATURE MEMORIZATION

HOW TO SEE THE MIN TEMPERATURE:

- 1) Press and release the down arrow ▼ key.
- 2) The “Lo” message will be displayed followed by the minimum temperature recorded.
- 3) Press the down arrow ▼ key again or wait 5 seconds to restore normal display.

HOW TO SEE THE MAX TEMPERATURE:

- 1) Press and release the up ▲ arrow key.
- 2) The “Hi” message will be displayed followed by the maximum temperature recorded.
- 3) Press the up arrow ▲ key again or wait 5 seconds to restore normal display.

HOW TO RESET THE MAX AND MIN TEMPERATURE RECORDED:

- 1) Press the SET key for more than 3 seconds while the max or min temperature is displayed. (rSt message will be displayed.)
- 2) To confirm the operation, the “rSt” message starts blinking and the normal temperature will be displayed.

MAIN FUNCTIONS

HOW TO SEE THE SETPOINT:

- 1) Press and immediately release the SET key. The display will show the set point value.
- 2) Press and immediately release the SET key, or wait 5 seconds to display the probe value again.

HOW TO CHANGE THE SETPOINT:

NOTE: The standard set point is 75°.

- 1) Press the SET key for more than 2 seconds to change the set point value.
- 2) The value of the set point will be displayed and the °C or °F LED starts blinking.
- 3) To change the set value push the up ▲ or down arrow ▼ keys within 10 seconds.
- 4) To store the new set point value push the SET key again, or wait 10 seconds.

HOW TO CHANGE A PARAMETER VALUE:

To change a parameter's value, operate as follows:

- 1) Enter the Programming mode by pressing the SET plus down arrow keys for 3 seconds (the °C or °F LED starts blinking).

- 2) Select the required parameter. Press the SET key to display its value.
- 3) Use up or down arrow keys to change its value.
- 4) Press SET to store the new value and move to the following parameter. To exit, press SET and the up arrow keys or wait 15 seconds without pressing a key.

NOTE: The set value is stored even when the procedure is exited by waiting for the time-out to expire.

HOW TO LOCK THE KEYBOARD:

- 1) Press and hold the up and down arrow keys simultaneously for more than 3 seconds.
- 2) The POF message will be displayed, and the keyboard will be locked. At this point, it will only be possible to see the set point or the MAX or MIN temperature stored.
- 3) If a key is pressed more than 3 seconds, the POF message will be displayed.

HOW TO UNLOCK THE KEYBOARD:

- 1) Press and hold the up and down arrow keys simultaneously for more than 3 seconds until the Pon message is displayed.

OPTIONAL MONITORING SYSTEM

TTL SERIAL LINE - FOR OPTIONAL MONITORING SYSTEMS:

The optional TTL serial line, available through the HOT KEY connector, allows through the use of the external TTL/RS485 converter, connection of this digital converter to a monitoring system that is ModBUS-RTU compatible (X-WEB500/3000/300). Connections are provided through an external 2-position terminal block.

Principles of Operation (con't)

RESETTING

If it becomes necessary to reset the unit, the factory settings are as follows:

PARAMETER	DESCRIPTION	VALUE	UNIT	RANGE	
				MINIMUM	MAXIMUM
SEt	Set Point	75	°F	60	95
Hy	Differential	10	°F	1	45
dP4	Fourth probe display	0	--	--	--
dP3	Third probe display	0	--	--	--
dP2	Evaporator probe display	0	--	--	--
dP1	Room probe display	0	--	--	--
AFH	Differential for temperature alarm recovery	2	°F	1	45
ALL	Minimum temperature alarm	35	°F	-67	120
ALU	Maximum temperature alarm	120	°F	35	302
SHy	Differential for auxiliary relay	5	°F	1	45
SAA	Set point for auxiliary relay	115	°F	-67	302
ACH	Kind of action for auxiliary relay	CL	--	--	--
AC	Anti-short cycle delay	2	min	0	50
odS	Outputs delay at start up	0	min	0	255
P2P	Evaporator probe presence	n	--	--	--
ot	Thermostat probe calibration	0	°F	-21	21
US	Maximum set point	95	°F	75	302
LS	Minimum set point	60	°F	-67	75
Ptb	Map code	7	--	0	65535
rEL	Software release	0	--	--	--
rSE	Real set point	0	--	--	--
onF	on/off key enabling	ES	--	--	--
PbC	Kind of probe	ntc	--	--	--
Adr	Serial address	1	--	1	247
HES	Differential for energy saving	0	°F	-54	54
rrd	Regulation restart with door open alarm	y	--	--	--
odc	Compress status when open door	no	--	--	--
nPS	Number of activation of pressure switch	15	--	0	15
did	Digital input alarm delay	5	min	0	255
i1F	Digital input configuration	EAL	--	--	--
i1P	Digital input polarity	cL	--	--	--
dAO	Delay of temperature alarm at startup	00:00	h	--	--
ALd	Temperature alarm delay	0	min	0	255
ALc	Temperature alarms configuration	Ab	--	--	--
ArP	Probe selection for auxiliary alarm	P1	--	--	--
dLy	Display temperature alarm	00:00	min.	0	20
Lod	Probe displayed	P1	--	--	--
rES	Resolution	in	--	--	--
CF	Temperature measurement unit	F	--	--	--
CH	Kind of action: heating cooling	cL	--	--	--
COF	Compressor OFF time with faulty probe	4	min	0	255
COOn	Compressor ON time with faulty probe	20	min	0	255
O4	Fourth probe calibration	0	°F	-21	21
P4P	Fourth probe presence	n	--	--	--
O3	Third probe calibration	0	°F	-21	21
P3P	Third probe presence	n	--	--	--
OE	Evaporator probe calibration	0	°F	-21	21

VI. Pre-Installation Testing

Before mounting the air conditioner to the enclosure, test for proper operation. This will verify the shipping integrity of the system. Please follow the steps below prior to installation.

CAUTION

The Air Conditioner must be standing in its proper mounting position for a minimum of five (5) minutes prior to testing. Failure to follow this procedure will cause permanent damage to the compressor.

1. Allow the unit to sit in a upright position at a room temperature of 65°F minimum, allowing the system to warm-up. This is particularly important in winter months.
2. Refer to the nameplate for proper electrical voltage and current requirements. Then connect the power cord to a properly grounded and fused electrical supply. Leave the electrical power off.
3. Note the factory thermostat setting which is typically 75 to 80°F.
4. Adjust the thermostat to its maximum setting. Refer to pages 5 and 6 for instructions on thermostat adjustment.
5. Turn electrical power on.
6. Verify that the evaporator blower or fan is running.
7. Observe the temperature on the digital display. The thermostat must be set a minimum of 10°F below this temperature for the compressor to operate (the factory setting is 75°F). Refer to page 6 for instructions on adjustment of the thermostat.
8. Verify that the condenser blower or fan is running. Note that the start of the condenser fan will be delayed until the system pressures rise.
9. Operate the air conditioner for approximately ten (10) minutes. During this period no unusual noise or vibration should be evident. Both the evaporator and condenser fans or blowers should be delivering air through their respective discharge ports. The cool air discharged should be less than 70°F when the room temperature is between 70 and 80°F. It is normal for the condenser blower to cycle on/off during this period.
10. Return the cooling thermostat to its original setting.
11. Turn off the electrical power source, and disconnect the air conditioner from the power source.
12. If any cover plug is removed to adjust the unit, make certain to put it back in place to maintain the integrity of the closed-loop airflow system.

NOTE: Before shipment all Kooltronic, Inc. Air Conditioners are subjected to a performance test.

VII. Specific Model Data

Kooltronic Air Conditioners have been engineered to be installed easily. To avoid damaging your air conditioner, please read the following information before installation.

Mounting

- Panel-mounted air conditioners are equipped with two vertical mounting rails. These rails can be mounted to any available vertical surface on the enclosure.
- Refer to page 10 for the location of all mounting holes and cutouts.
- Make sure the cutouts don't interfere with components inside your cabinet.
- Proper alignment of all air inlets and outlets is essential for optimum performance of the air conditioner.
- All externally-mounted air conditioners are fully gasketed to ensure proper sealing. This seal is necessary to maintain the integrity of the closed loop system.
- Use all existing mounting holes to ensure stability and a tight seal.
- High strength mounting screws are recommended.
- Attach the brass drain pan fitting and drain hose supplied to the drain exit on the bottom or lower side panel of the air conditioner.
- The external drain hose must not be elevated above the exit port. Improper mounting will impede

CAUTION

If the air conditioner is mounted to the cabinet door you must be sure that the door hinges will support the additional weight of the air conditioner. Also be certain that when the door is opened fully, the cabinet does not become unbalanced. The actual weight of the unit can be found in the Technical Data on page 12.

Drawings and Dimensions

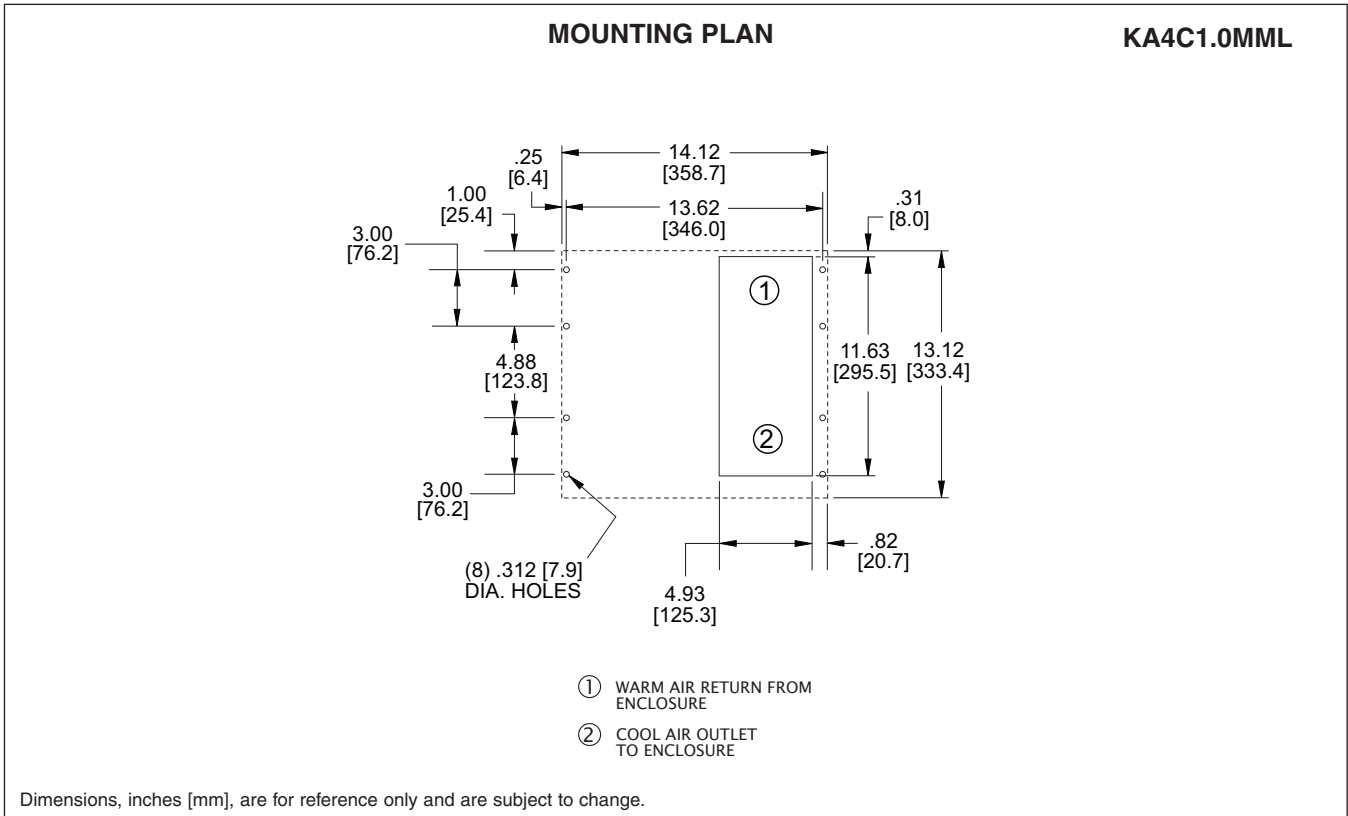

Drawings and Dimensions

- ① FILTERED CONDENSER AIR INLET (Ambient Air In)
- ② CONDENSER OUTLET (Warm Ambient Air Out)
- ③ WARM AIR RETURN FROM ENCLOSURE
- ④ COOL AIR OUTLET TO ENCLOSURE

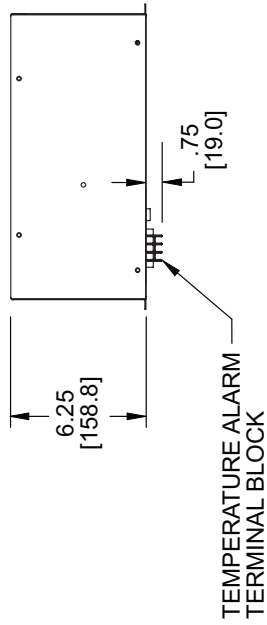

NOTE: REMOVE TOP PANEL TO ACCESS PROGRAMMABLE THERMOSTAT

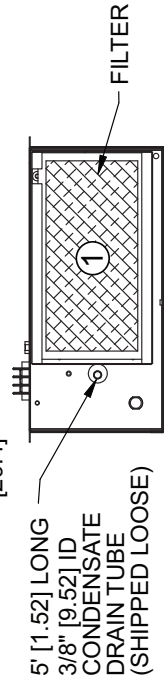
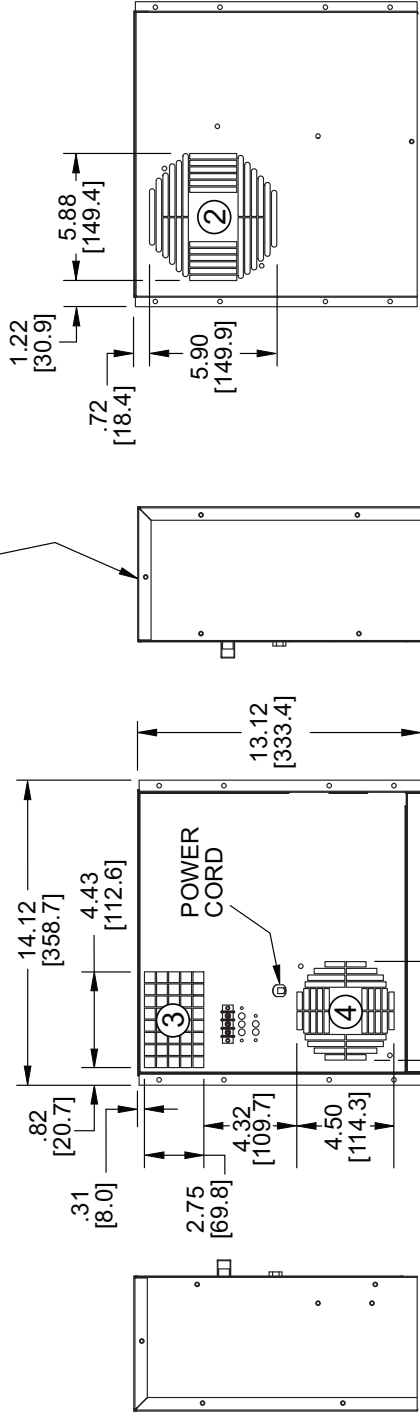

Dimensions (inches) are for reference only and are subject to change.

GA17301A

Technical Data

Model	BTU/H Capacity	BTU/H 95°F/95°F	Ambient Temp. °F Max./Min.	Volts	Hz	Running Amps 131°F/131°F	Approximate Weight (lbs.)
KA4C1.0MML	1000	850	125/-20	115/100	60/50	2.7	30.5
KA4C1.4MML-6	1400	850	125/-20	115/100	60/50	2.7	30.5

Major Component Replacements

Part	KA4C1.0MML Part Number	KA4C1.0MML-6 Part Number
Compressor	0665-124	0665-124
Compressor Capacitor	0452-84	0452-84
Condenser Blower Motor	0265-03	0265-03
Evaporator Blower Motor	0265-09	0265-09
Filter	5001F	5001F
Pressure Switch	0712-18	0712-18
Programmable Thermostat	0750-136	0750-136

NOTE: Part Numbers shown are for 115V 60 Hz. For 230V 60 Hz and all 50 Hz consult Kooltronic.

Standard Features

Ball-bearing Motors
 CFC-Free Refrigerant
 Closed-Loop Cooling
 Compressor Short Cycle Protector
 Filter
 NEMA 12 Rating Maintained (UL50)
 Programmable Thermostat
 Temperature Alarm
 UL/CUL Listed

Accessories and Options

Adaptor
 Aluminum Shell
 Filter Recoating Adhesive
 High-Capacity Condensate Evaporator
 Internal Corrosion Protection
 Lifting Eyes
 Mounting Hinge
 Remote Monitoring
 Remote Thermostat Relay
 Replacement Filters
 Special materials or finishes
 Stainless Steel Shell
 Weather Protection Kit

VIII. Maintenance

Kooltronic Water-Cooled Air Conditioners require no maintenance. Air-Cooled Air Conditioners are designed to require only the routine cleaning of air filters to assure unimpeded air flow through the condenser heat exchanger. It is not possible to recommend specific filter cleaning intervals since the level and the nature of airborne particulate matter differs widely with each installation. It is generally sufficient to remove and wash the reusable aluminum mesh air filters when the outer surfaces of these filters appear covered with a thin layer of dust or lint. Filter recoating adhesive is recommended. Appropriate disposable filters are available from Kooltronic.

If filter service is neglected or delayed, the air conditioner will not perform at its design capacity. The first indication of excessively clogged air filters is usually a gradual increase of temperature within the equipment cabinet. If operation is continued under these conditions, the compressor will be shut off by the thermal overload device. The compressor will restart when its external temperature drops below the protector threshold setting and the compressor will continue to cycle on and off. Continued operation under these conditions will cause damage, shorten compressor life and void the warranty.

A. Filter Removal and Service

Kooltronic Air Conditioners feature an easily removable inlet filter to facilitate necessary cleaning.

CAUTION

Do not operate the Air Conditioner for extended periods of time with the filter removed. The condenser coil may become clogged with dust or lint from the air entering the face. A clogged condenser coil is not readily detected and will give the same reaction as a clogged filter. A clean filter is the best protection.

- 1) Lift the filter using the attached tab to clear the lower filter retainer.
- 2) After removal, the filters should be flushed under warm running water with the clean side up, driving contaminants out the dirty side of the filter. If the accumulated dirt is oily, washing in a detergent bath is recommended, followed by a warm water rinse as above.
- 3) The filters may be sprayed with **Kooltronic A-16 Filter Recoating Adhesive** to trap fine airborne contaminants, or they may simply be dried and reinstalled as strainer type filters. **Recoating is recommended for best results.**
- 4) Reinstall the filter: (a) keeping the tab at the bottom, slide filter into the upper retainer, (b) press filter against the unit and, (c) slide down into lower retainer.

B. Blowers

The design life of the blowers employed in all Kooltronic Air Conditioners is substantially in excess of 20,000 hours. All Kooltronic condenser and evaporator blowers are equipped with UL/CSA permanently-lubricated precision ball-bearing motors, with automatic-reset thermal overload protectors.

CAUTION

Before opening the Air Conditioner, disconnect all power.

If field replacement of a blower motor is necessary, most blower assemblies, including mounting plate, are readily removable. Each of the blower mounting plates is held to the air conditioner cabinet structure by screws and nuts. For installation of the replacement blower, electrical connections may be broken at the terminal block, or power leads may be cut and appropriately spliced together.

C. Compressor

All Kooltronic compressors are approved by UL and CSA, and require no maintenance. They are hermetically sealed and charged at the factory, and equipped with automatic-reset thermal overload protectors.

If the compressor or the hot gas bypass valve fails, it is strongly recommended that the Air Conditioner be returned to Kooltronic for service.

D. Refrigerant Loss

Kooltronic Air Conditioners are subjected to a series of tests to detect refrigerant leaks, during and after manufacture. It is possible that shipping or other damage, or microscopic leaks over a long period, may result in the need for replenishment of refrigerant charge. **When it has been verified by a Certified EPA Technician that a refrigerant shortage does exist, the leak must be repaired. Then the unit may be evacuated and recharged in the field by a Certified EPA Technician only.**

CAUTION

Refer to the data on the unit nameplate which specifies the type of refrigerant and the amount of charge in ounces.

E. Relocation

If your Kooltronic Air Conditioner has to be moved to another location by truck, the following precautions should be taken:

- De-mount Air Conditioner from equipment, controller or enclosure.
- Conform to the applicable provisions of PROCEDURE FOR PROPER PACKING AND SHIPMENT OF KOOLTRONIC AIR CONDITIONERS in this manual under *Section III. "PRODUCT HANDLING"*.

IX. Trouble-Shooting

Each Kooltronic Air Conditioner is engineered for performance and built for reliability. They are designed to require no routine maintenance other than the cleaning of ambient air filters. If your air conditioner should require service, we have compiled a trouble-shooting chart to assist your service personnel. If additional assistance is required contact Kooltronic at (609) 466-3400.

Problem	Cause	Solution
Unit not Cooling	No Power	Check Power Source and Electrical Connections
	Loss of Refrigerant	Locate and repair leak
	Evaporator or Condenser Blower not operating	Replace Motor, Capacitor or entire Assembly
	Filter clogged	Clean or replace Filter
	Clogged Evaporator or Condenser Coil	Clean Coil
	Low Temperature Control (Thermostat) improperly set	Lower setting until unit starts
	Low Temperature Control (Thermostat) defective	Replace Thermostat or Relay when applicable
Ice on Evaporator Coil	Failed Compressor	Replace Compressor
	Insufficient Heat Load or Unit Oversized for Application	Contact Kooltronic
	Failed Evaporator Blower	Replace Evaporator Blower Motor or Assembly
Condensate draining continuously	Clogged Evaporator Coil	Clean Coil
	Enclosure not properly sealed	Check and seal all openings
Excessive vibration	Excessive opening of Enclosure	Eliminate the frequency of door opening
	Defective Motor in Blower	Replace Motor
	Defective Wheel in Blower	Replace Wheel
Compressor Inoperative	Compressor Loose	Tighten Mounting Bolts
	Low line Voltage	Check Nameplate Voltage against supply
	Loss of Compressor Oil	Replace Compressor
	Loss of Refrigerant	Locate and repair leak
	Failed Compressor Capacitor	Replace Capacitor
	Thermal Overload	Contact Kooltronic
Refrigerant or Oil leaks	Power interruptions	Allow Compressor time to reset
	Crack or pin hole in tubing or brazed joint	Replace tubing or rebrase joint
Condensate on the outside surface of the Enclosure	Insufficient Heat Load or Unit oversized for application	Contact Kooltronic