



**TRIMLINE
KA4C4NP33L**
with Serial Numbers above L17A3573
K2A4C4NP33L
with Serial Numbers above M17A4068

Keep This Manual With Air Conditioner

Find additional information on this model at kooltronic.com, or use the Technical Documents QR code below.

Technical Documents



AIR CONDITIONER OPERATOR'S MANUAL

CAUTION

BEFORE INSTALLING AND USING THIS AIR CONDITIONER, IT IS IMPORTANT THAT THIS MANUAL BE READ AND UNDERSTOOD THOROUGHLY



KOOLTRONIC, INC.
30 Pennington-Hopewell Road
Pennington, NJ 08534
609•466-3400
FAX: 609•466-1114
www.kooltronic.com

TABLE OF CONTENTS

		Page
I.	Introduction	2
II.	Incoming Inspection	3
III.	Product Handling	3
IV.	Product Identification and Nameplate	4
V.	Principles of Operation	5 - 7
VI.	Pre-Installation Testing	8
VII.	Specific Model Data	9 - 12
	Mounting	
	Drawings and Dimensions	
	Technical Data	
	Major Component Replacements	
	Standard Features	
VIII.	Maintenance	13 - 14
IX.	Trouble Shooting	14 - 15
X.	Warranty	16

NOTE: Wiring Schematics are available on the specific model page of the Kooltronic website.

I. Introduction

Kooltronic Air Conditioners are designed to provide a cool, dehumidified environment for your electronic components. There are models to fit virtually all sizes and shapes of electronics enclosures, in capacities ranging from 1,000 to 30,000 BTU/H. Our "closed-loop" design also ensures that your components will not be exposed to hot, dirty operating conditions.

This Manual provides you with the necessary general information for properly installing and operating standard Kooltronic Air Conditioners. Technical data and mounting instructions are presented on pages 9 through 12.

II. Incoming Inspection

Kooltronic Air Conditioners are designed, built and packaged to withstand the shock and vibration normally associated with shipment by common carriers. Occasionally improper handling during shipping causes damage. Such handling could include unbanding of palletized shipments, failing to respect "**This Side Up**" arrows, rough handling, falling off conveyors, excessive vibration, crushing, etc. Therefore, a thorough inspection should be done upon receipt of all shipments. Any carton tears, dents, scratches, loose articles or evidence of oil are signs of damage and should be noted on the Freight Bill. Cartons should be opened promptly and the units inspected for CONCEALED DAMAGE. Kooltronic Air Conditioners must be delivered in the proper mounting position to assure that damage to the compressor has not occurred during shipping. Any Kooltronic Air Conditioner that is delivered removed from the banded pallet, lying down or double stacked should be refused.

An immediate claim **MUST** be filed with the freight carrier and an inspection requested. Retain all packing materials. Kooltronic cannot assume responsibility for Consignee's failure to file a timely freight claim.

III. Product Handling:

- 1) Do not attempt to operate your Kooltronic Air Conditioner until you read and thoroughly understand this Manual. See section **VI PRE-INSTALLATION TESTING**.
- 2) Before operating the Kooltronic Air Conditioner be certain that it is placed in its correct mounting position. **This Air Conditioner is designed to operate in a vertical position only.** This placement must be done a minimum of 5 minutes prior to operating in order to allow the compressor oil to drain to the compressor sump area.

CAUTION

Kooltronic Air Conditioners must be operated in their proper mounting position. If attempts are made to operate a unit that is not in its designed mounting position, permanent compressor damage will occur. This action will void the warranty. To avoid compressor damage do not tip the unit more than 45° from its proper mounting position.



- 3) Before operating this unit, all electrical wiring must be checked to assure the proper connection to the correct power source. Minimum circuit ampacity should be at least 125% of the amperage found on the nameplate for the corresponding voltage. Do not exceed the maximum fuse size found on the nameplate.
- 4) We do not recommend that Air Conditioners be shipped to their final destination attached to an enclosure. In the event that the Air Conditioner needs to be shipped attached to an enclosure it is strongly recommended that proper support be provided for the Air Conditioner. Excessive vibration can occur if Air Conditioners are not properly supported when shipped on enclosures, increasing the potential for internal damage and voiding the warranty.
- 5) **PROCEDURE FOR PROPER PACKING AND SHIPMENT OF KOOLTRONIC AIR CONDITIONERS:**
 - Keep Air Conditioner in proper upright position indicated by arrow markers.
 - Pack Air Conditioner in an appropriate carton (preferably original carton if possible), with adequate internal protective packaging, making sure carton is marked and is kept in correct upright position.
 - For local, controlled transportation, strap carton to a secure part of truck to prevent falling or sliding, minimize vibration, etc.
 - For common carrier shipment, band unit(s) securely to a pallet. Unpalletted shipment risks severe damage which voids the warranty.

IV. Product Identification and Nameplate

Each Kooltronic Air Conditioner includes an identification nameplate. This nameplate provides:

- ① Model Number
- ② Serial Number
- ③ Electrical power characteristics
- ④ Maximum and minimum ambient operating temperatures
- ⑤ Cooling capacity
- ⑥ Type and amount of refrigerant required for recharging
- ⑦ Design Pressure
- ⑧ Maximum Fuse Size
- ⑨ Manufacturing Order Number
- ⑩ Filter Part Number
- ⑪ Underwriters Laboratories Inc. Listed or Recognized Marks and NEMA ratings

We recommend you copy this information from your unit.

		Air Conditioner				
						MODEL NUMBER
①				②		
VOLTS	FREQ.	PH.	COOLING F.L.A.	AMBIENT TEMP. MIN. °F MAX. °F		
③	③	③	③	④	④	
COOLING BTU			REFRIGERANT	Oz.		
⑤			⑥			
DESIGN PRESSURE P.S.I.G.		FUSE SIZE MAX.				
LOW	HIGH	⑧				
⑦	⑦	MFG. ORDER NO.				
		⑨				
		FILTER P/N				
		⑩				
		⑪				
						
SPECIAL PURPOSE AIR CONDITIONER NEMA/EEMAC/UL50 BY UNDERWRITERS LABORATORIES, INC. TYPE 12 INTERFACE TO THE ELECTRICAL ENCLOSURE ONLY NEMA/EEMAC/UL50 BY UNDERWRITERS LABORATORIES, INC. TYPE 1 SPECIAL PURPOSE AIR CONDITIONER EQUIPMENT COMPARTMENT ONLY SERVICE AIR FILTER REGULARLY ALLOW 5 MIN. BEFORE RESTARTING AFTER SHUTDOWN UNAUTHORIZED SERVICE OR MODIFICATION VIOLATES WARRANTY ALL MOTORS ARE THERMALLY PROTECTED						
MANUFACTURED BY: KOOLTRONIC, INC. PENNINGTON, NJ						
						

①②⑨ When ordering parts, specify the Model Number, Serial Number & MFG. Order Number.

③ Before operating, be sure that the power source matches these requirements.

④ Make sure that these parameters are met. Failure to do so may result in permanent damage to the unit.

⑥ Use of incorrect type or amount of refrigerant will adversely affect performance and may damage the unit.

V. Principles of Operation

Kooltronic Air Conditioners are required when the equipment operating temperature must be kept near or lower than the ambient room temperature, and/or the cabinet must be sealed from dust, fumes, oil, corrosives and other contaminants. These Air Conditioners utilize a "Closed-Loop Cooling System" to ensure optimum performance of the installed components.

Closed-Loop cooling seals the electronic enclosure from hostile elements in the environment. Two separate circulation systems are employed. The internal system cools and dehumidifies the air inside the cabinet, totally isolating the sensitive electronics and other components from the environment. The external system uses circulating ambient air or water to discharge the heat removed from the electronics. The heat is dissipated from the enclosure by means of the vapor compression refrigeration cycle. This takes place in a hermetically-sealed refrigeration system, utilizing either an air-cooled or water-cooled condenser heat exchanger. The warm air inside the enclosure is drawn through the evaporator coil where it is cooled, dehumidified and returned.

Any enclosure moisture accumulated on the evaporator coil is collected in the condensate tray and removed through the drain tube to the condensate evaporator. Condensate evaporates in the condensate evaporator and is released to the ambient air by the condenser impeller.

The heat removed through the evaporator coil is transferred by the compressed refrigerant to the condenser coil. Ambient air is then passed through the condenser coil, where it absorbs the heat and is then discharged to the environment.

When the Kooltronic Air Conditioner is properly sized it should operate constantly and maintain 75°F to 115°F enclosure temperature, depending on the ambient temperatures.

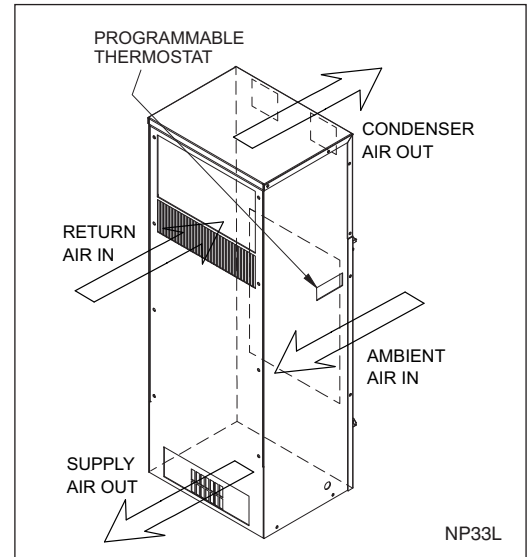

CONTROL ACTION

The evaporator blower operates continuously. The compressor is cycled on and off by the action from the factory preset programmable thermostat. A pressure switch controls the on/off action of the condenser blower.

The regulation is performed according to the temperature measured by the thermostat probe with a positive differential from the set point: if the temperature increases and reaches set point plus differential the compressor is started and then turned off when the temperature reaches the set point value again.

In case of fault in the thermostat probe the start and stop of the compressor are timed through preset parameters.

The programmable thermostat is located as shown in the upper right ISO illustration. **WARNING:** the programmable device is preprogrammed and set at the factory. In the event changes are needed the following instructions can be used.

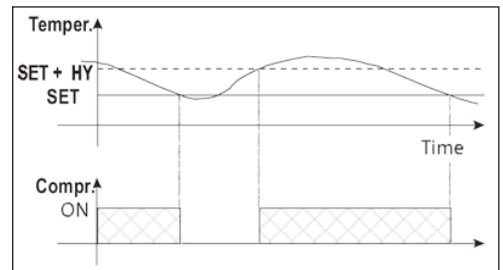

FRONT PANEL COMMANDS



KEY COMBINATIONS

- + To lock and unlock the keyboard.
- SET + To return to the room temperature display.
- SET + To enter programming mode.

- SET - To display target set point; in programming mode it selects a parameter or confirms an operation.
- (UP) - To see the max. stored temperature; in programming mode it browses the parameter codes or increases the displayed value.
- (DOWN) - To see the min. stored temperature; in programming mode it browses the parameter codes or decreases the displayed value.
- To switch the instrument off, if onF = off.
- Not enabled.
- (DEF) - To start a manual defrost.

FRONT PANEL LED INDICATORS

LED	LED Functions	
	MODE	FUNCTION
	ON	Compressor enabled
	Flashing	Anti-short cycle delay enabled
	ON	An alarm is occurring
	ON	Continuous cycle is running (not enabled)
	ON	Energy saving (not enabled)
°F	ON	Measurement unit
°F	Flashing	Programming phase

Principles of Operation (con't)

MAX AND MIN TEMPERATURE MEMORIZATION

HOW TO SEE THE MIN TEMPERATURE:

- 1) Press and release the down arrow ▼ key.
- 2) The "Lo" message will be displayed followed by the minimum temperature recorded.
- 3) Press the down arrow ▼ key again or wait 5 seconds to restore normal display.

HOW TO SEE THE MAX TEMPERATURE:

- 1) Press and release the up ▲ arrow key.
- 2) The "Hi" message will be displayed followed by the maximum temperature recorded.
- 3) Press the up arrow ▲ key again or wait 5 seconds to restore normal display.

HOW TO RESET THE MAX AND MIN TEMPERATURE RECORDED:

- 1) Press the SET key for more than 3 seconds while the max or min temperature is displayed. (rSt message will be displayed.)
- 2) To confirm the operation, the "rSt" message starts blinking and the normal temperature will be displayed.

MAIN FUNCTIONS

HOW TO SEE THE SETPOINT:

- 1) Press and immediately release the SET key. The display will show the set point value.
- 2) Press and immediately release the SET key, or wait 5 seconds to display the probe value again.

HOW TO CHANGE THE SETPOINT:

NOTE: The standard set point is 75°.

- 1) Press the SET key for more than 2 seconds to change the set point value.
- 2) The value of the set point will be displayed and the °C or °F LED starts blinking.
- 3) To change the set value push the up ▲ or down arrow ▼ keys within 10 seconds.
- 4) To store the new set point value push the SET key again, or wait 10 seconds.

HOW TO CHANGE A PARAMETER VALUE:

To change a parameter's value, operate as follows:

- 1) Enter the Programming mode by pressing the SET plus down arrow keys for 3 seconds (the °C or °F LED starts blinking).

- 2) Select the required parameter. Press the SET key to display its value.
- 3) Use up or down arrow keys to change its value.
- 4) Press SET to store the new value and move to the following parameter. To exit, press SET and the up arrow keys or wait 15 seconds without pressing a key.

NOTE: The set value is stored even when the procedure is exited by waiting for the time-out to expire.

HOW TO LOCK THE KEYBOARD:

- 1) Press and hold the up and down arrow keys simultaneously for more than 3 seconds.
- 2) The POF message will be displayed, and the keyboard will be locked. At this point, it will only be possible to see the set point or the MAX or MIN temperature stored.
- 3) If a key is pressed more than 3 seconds, the POF message will be displayed.

HOW TO UNLOCK THE KEYBOARD:

- 1) Press and hold the up and down arrow keys simultaneously for more than 3 seconds until the Pon message is displayed.

OPTIONAL MONITORING SYSTEM

TTL SERIAL LINE - FOR OPTIONAL MONITORING SYSTEMS:

The optional TTL serial line, available through the HOT KEY connector, allows through the use of the external TTL/RS485 converter, connection of this digital converter to a monitoring system that is ModBUS-RTU compatible (X-WEB500/3000/300). Connections are provided through an external 2-position terminal block.

Principles of Operation (con't)

RESETTING

If it becomes necessary to reset the unit, the factory settings are as follows:

PARAMETER	DESCRIPTION	VALUE	UNIT	RANGE	
				MINIMUM	MAXIMUM
SEt	Set Point	75	°F	60	95
Hy	Differential	10	°F	1	45
dP4	Fourth probe display	0	--	--	--
dP3	Third probe display	0	--	--	--
dP2	Evaporator probe display	0	--	--	--
dP1	Room probe display	0	--	--	--
AFH	Differential for temperature alarm recovery	2	°F	1	45
ALL	Minimum temperature alarm	35	°F	-67	120
ALU	Maximum temperature alarm	120	°F	35	302
SHy	Differential for auxiliary relay	5	°F	1	45
SAA	Set point for auxiliary relay	115	°F	-67	302
ACH	Kind of action for auxiliary relay	CL	--	--	--
AC	Anti-short cycle delay	2	min	0	50
odS	Outputs delay at start up	0	min	0	255
P2P	Evaporator probe presence	n	--	--	--
ot	Thermostat probe calibration	0	°F	-21	21
US	Maximum set point	95	°F	75	302
LS	Minimum set point	60	°F	-67	75
Ptb	Map code	7	--	0	65535
rEL	Software release	0	--	--	--
rSE	Real set point	0	--	--	--
onF	on/off key enabling	ES	--	--	--
PbC	Kind of probe	ntc	--	--	--
Adr	Serial address	1	--	1	247
HES	Differential for energy saving	0	°F	-54	54
rrd	Regulation restart with door open alarm	y	--	--	--
odc	Compress status when open door	no	--	--	--
nPS	Number of activation of pressure switch	15	--	0	15
did	Digital input alarm delay	5	min	0	255
i1F	Digital input configuration	EAL	--	--	--
i1P	Digital input polarity	cL	--	--	--
dAO	Delay of temperature alarm at startup	00:00	h	--	--
ALd	Temperature alarm delay	0	min	0	255
ALc	Temperature alarms configuration	Ab	--	--	--
ArP	Probe selection for auxiliary alarm	P1	--	--	--
dLy	Display temperature alarm	00:00	min.	0	20
Lod	Probe displayed	P1	--	--	--
rES	Resolution	in	--	--	--
CF	Temperature measurement unit	F	--	--	--
CH	Kind of action: heating cooling	cL	--	--	--
COF	Compressor OFF time with faulty probe	4	min	0	255
COn	Compressor ON time with faulty probe	20	min	0	255
O4	Fourth probe calibration	0	°F	-21	21
P4P	Fourth probe presence	n	--	--	--
O3	Third probe calibration	0	°F	-21	21
P3P	Third probe presence	n	--	--	--
OE	Evaporator probe calibration	0	°F	-21	21

VI. Pre-Installation Testing

Before mounting the air conditioner to the enclosure, test for proper operation. This will verify the shipping integrity of the system. Please follow the steps below prior to installation.

CAUTION

The air conditioner must be standing in its proper mounting position for a minimum of five (5) minutes prior to testing. Failure to follow this procedure will cause permanent damage to the compressor. To avoid compressor damage do not tip the unit more than 45° from its proper mounting position.

1. The unit must sit in an upright position at a minimum room temperature of 65°F to allow the system to warm-up. This is particularly important during winter months.
2. Refer to the nameplate for proper electrical voltage and current requirements. Connect the power cord to a properly grounded and fused electrical supply, leaving electrical power to the unit turned off.
3. Note the factory thermostat setting which is 75° F.
4. If the unit is equipped with an on-off switch, move it to the on position.
5. Turn the electrical power on.
6. Verify that the evaporator blower is running.
7. Observe the temperature on the digital display. The thermostat must be set at a minimum of 10°F below this temperature for the compressor to operate (the factory setting is 75°F). Refer to page 6 for instructions on adjustment of the thermostat.
8. Verify that the condenser air mover is running. The start of the condenser air mover will be delayed until the system pressures rise.
9. Operate the air conditioner for approximately ten (10) minutes. During this period no unusual noise or vibration should be evident. Both the evaporator and condenser air movers should be delivering air through their respective discharge ports. The cool air discharged should be less than 70°F when the room temperature is between 70°F and 80°F. It is normal for the condenser blower to cycle on/off during this period.
10. On units equipped with heaters, adjust both the cooling and heating thermostats to their maximum settings. Verify that the compressor and condenser fan or blower has stopped. Verify elevated discharge air temperature from the evaporator air discharge.
11. If the unit is equipped with an on-off switch, leave it in the on position. Return the cooling thermostat to its original setting. If the unit is equipped with a heater, return the heating thermostat to its original position.
12. Turn off the electrical power and disconnect the air conditioner from the power source.
13. If any cover was removed to adjust the unit, be sure to replace it in order to maintain the integrity of the closed-loop airflow system.

NOTE: Before shipment all Kooltronic Air Conditioners are subjected to a performance test.

VII. Specific Model Data

Mounting

The Kooltronic Special Purpose Air Conditioners K_A4C4NP33L have been engineered to be installed easily. Prior to mounting, refer to page 11 for the general arrangement drawings showing dimensions and locations of mounting holes and cutouts. Prior to cutting or drilling, make sure that cutouts and mounting holes do not interfere with components inside the cabinet. To avoid damaging your air conditioner, please read the following information before installation:

1. Remove and save the four screws holding the Mounting Template and Assembly Bracket (M/TAB) to the unit. Remove the M/TAB.
2. Place the M/TAB flush against the outside of the cabinet to locate cutouts and mounting holes.
3. NOTE: The top cutout for the warm air return does not have to match the full 9" opening on the M/TAB. You can locate your cutout anywhere within this opening. Locate your cutout close to the top and not less than 3" high. Make sure the cutouts don't interfere with components inside your cabinet.
4. Mount the M/TAB to the outside of the cabinet using all the mounting hardware supplied by Kooltronic (1/4 -20 screws/nuts/washers). NOTE: Make sure the screws are inserted with heads on M/TAB side. Tighten nuts securely.
5. Route the power cord through the top cut out in your cabinet. Mount the unit to the M/TAB by sliding the studs located on each side panel into the slots on the M/TAB.
6. Insert the remaining 10-32 screws and seal washers supplied by Kooltronic through the Air Conditioner side panel and into the M/TAB. To avoid misalignment of parts do not tighten any of the screws until they are all installed. Be careful not to overtighten the screws.
7. Attach overflow drain hose supplied to the drain exit in the side or bottom of the unit. This hose must not be elevated above the exit port. Improper mounting will impede the flow of condensate and may cause internal malfunctions.

CAUTION

If the air conditioner is mounted to the cabinet door you must be sure that the door hinges will support the additional weight of the air conditioner. Also be certain that when the door is opened fully, the cabinet does not become unbalanced. The actual weight of the unit can be found in the Technical Data on page 12.

Drawings and Dimensions

MOUNTING PLAN

K_A4C4NP33L

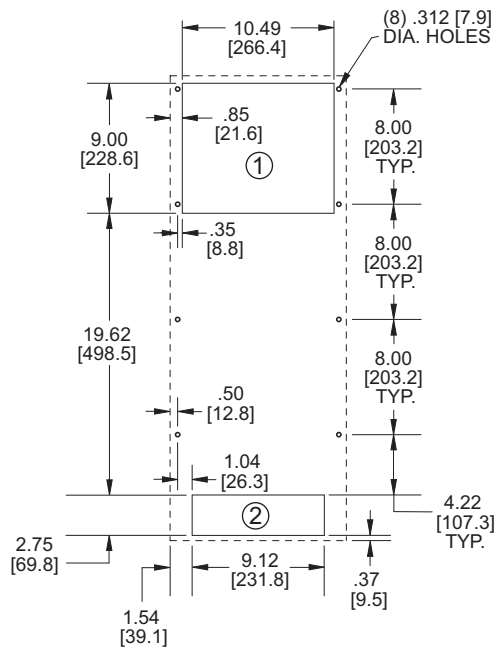

- ① WARM AIR RETURN FROM ENCLOSURE
- ② COOL AIR OUTLET TO ENCLOSURE

Dimensions, inches [mm], are for reference only and are subject to change.

Drawings and Dimensions

K_A4C4NP33L

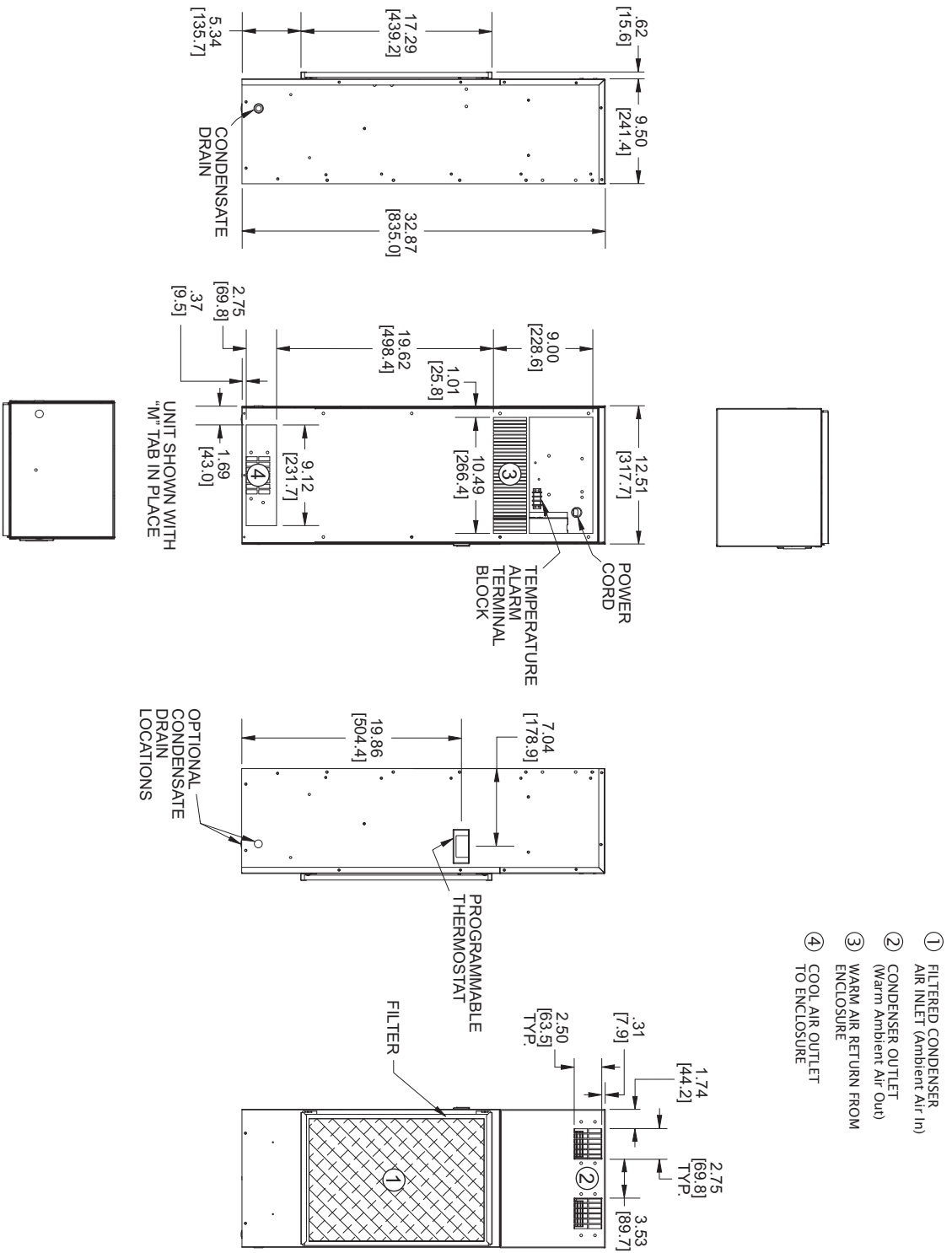

Dimensions (inches) are for reference only and are subject to change.

GA609033A

Technical Data

Model	BTU/H Capacity	BTU/H 95°F/95°F	Ambient Temp. °F Max./Min.	Volts	Hz	Running Amps	Fuse Amps	Approximate Weight (lbs.)
KA4C4NP33L	4000	2770	125/50	115/100	60/50	9.3/10.0	15	90
K2A4C4NP33L	4000	2283	120/50	230/200	60/50	5.5	15	90

Major Component Replacements

Part	KA4C4NP33L Part Number	K2A4C4NP33L Part Number
Compressor	0665-141	0665-139
Condenser Blower Motor	0261-08	0261-54
Condenser Blower Motor Capacitor	0452-03	0452-03
Condenser Blower Assembly	609033-T0-124	609033-T0-125
Evaporator Blower Motor	0261-97	950-005-89
Evaporator Blower Motor Capacitor	0452-03	0452-03
Evaporator Blower Assembly	609033-T0-93	609033-T0-92
Programmable Thermostat	0750-136	0750-137
Filter	12251F	12251F

Standard Features

Baked Powder Finish
Built-in Condensate Evaporator
CFC-Free Refrigerant
Compressor Short Cycle Protector
Epoxy-Coated Coils
Filter
Low Ambient Kit
NEMA 12 Rating Maintained (UL50)
Programmable Temperature Alarm
Programmable Thermostat
UL/CUL Listed

Accessories and Options

Filter Recoating Adhesive
Internal Corrosion Protection
Lifting Eyes
Remote Monitoring
Remote Thermostat Relay
Replacement Filters
Special Controls or Indicators
Special materials or finishes
Special motors, line cords or connectors

VIII. Maintenance

Kooltronic Water-Cooled Air Conditioners require no maintenance. Air-Cooled Air Conditioners are designed to require only the routine cleaning of air filters to assure unimpeded airflow through the condenser heat exchanger. It is not possible to recommend specific filter cleaning intervals since the level and the nature of airborne particulate matter differs widely with each installation. It is generally sufficient to remove and wash the reusable aluminum mesh air filters when the outer surfaces of these filters appear covered with a thin layer of dust or lint. Filter recoating adhesive is recommended. Appropriate disposable filters are available from Kooltronic.

If filter service is neglected or delayed, the air conditioner will not perform at its design capacity. The first indication of excessively clogged air filters is usually a gradual increase of temperature within the equipment cabinet. If operation is continued under these conditions, the compressor will be shut off by the thermal overload device. The compressor will restart when its external temperature drops below the protector threshold setting and the compressor will continue to cycle on and off. Continued operation under these conditions will cause damage, shorten compressor life and void the warranty.

A. Filter Removal and Service

Kooltronic Air Conditioners feature an easily removable inlet filter to facilitate necessary cleaning.

CAUTION

Do not operate the Air Conditioner for extended periods of time with the filter removed. The condenser coil may become clogged with dust or lint from the air entering the face. A clogged condenser coil is not readily detected and will give the same reaction as a clogged filter. A clean filter is the best protection.

- 1) Lift the filter using the attached tab to clear the lower filter retainer.
- 2) After removal, the filters should be flushed under warm running water with the clean side up, driving contaminants out the dirty side of the filter. If the accumulated dirt is oily, washing in a detergent bath is recommended, followed by a warm water rinse as above.
- 3) The filters may be sprayed with **Kooltronic A-16 Filter Recoating Adhesive** to trap fine airborne contaminants, or they may simply be dried and reinstalled as strainer type filters. **Recoating is recommended for best results.**
- 4) Reinstall the filter: (a) keeping the tab at the bottom, slide filter into the upper retainer, (b) press filter against the unit and, (c) slide down into lower retainer.

B. Compressor

All Kooltronic compressors are approved by UL and CSA, and require no maintenance. They are hermetically sealed and charged at the factory, and equipped with automatic-reset thermal overload protectors.

If the compressor or the hot gas bypass valve fails, it is strongly recommended that the Air Conditioner be returned to Kooltronic for service.

C. Refrigerant Loss

Kooltronic Air Conditioners are subjected to a series of tests to detect refrigerant leaks, during and after manufacture. It is possible that shipping or other damage, or microscopic leaks over a long period, may result in the need for replenishment of refrigerant charge. **When it has been verified by a Certified EPA Technician that a refrigerant shortage does exist, the leak must be repaired. Then the unit may be evacuated and recharged in the field by a Certified EPA Technician only.**

CAUTION

Refer to the data on the unit nameplate which specifies the type of refrigerant and the amount of charge in ounces.

Before opening the Air Conditioner, disconnect all power.

D. Relocation

If your Kooltronic Air Conditioner has to be moved to another location by truck, the following precautions should be taken:

- De-mount Air Conditioner from equipment, controller or enclosure.
- Conform to the applicable provisions of PROCEDURE FOR PROPER PACKING AND SHIPMENT OF KOOLTRONIC AIR CONDITIONERS in this manual under *Section III. "PRODUCT HANDLING"*.

IX. Trouble-Shooting

Each Kooltronic Air Conditioner is engineered for performance and built for reliability. They are designed to require only routine maintenance. If your air conditioner should require warranty service, please contact Kooltronic. If you require service out of warranty, we have compiled a trouble-shooting chart to assist your service personnel. If additional assistance is required contact Kooltronic at (609) 466-3400.

Problem	Cause	Solution
Unit does not run.	No Power.	Check Power Source and electrical connection. Check unit ON-OFF switch (UL Listed units only). Check unit power cord connection to terminal block.
Compressor and condenser fan do not run. Unit not cooling. Evaporator Blower is running. Compressor and Condenser Blower do not run.	Return temperature is between Thermostat set point and differential (75°F to 86°F).	Normal Operation. Check return air temperature. Check sensor connection on Thermostat.
Unit not cooling. (Temperature difference between return and supply air is less than 10°F). Evaporator Blower is running. Compressor and Condenser Blower do not run. Return temperature is above set point plus differential (90°F).	Failed Thermostat or Relay. Low Line Voltage. Failed Compressor.	Check Thermostat and Relay wire connections. Replace Thermostat or Relay. Check Nameplate Voltage against supply Voltage. Check Compressor wire connections. Check Compressor overload. Check Compressor Capacitor. Replace Compressor.

Problem	Cause	Solution
Unit not cooling. (Temperature difference between return and supply air is less than 10°F). Compressor and Condenser Blower are running. Evaporator Blower does not run.	Failed Evaporator Blower.	Check Blower wire connections. Check blower capacitor. Replace Evaporator Blower.
Unit not cooling. (Temperature difference between return and supply air is less than 10°F). Compressor and Evaporator Blower are running. Condenser Blower does not run.	Low Refrigerant charge. Failed Condenser Blower. Failed Speed Controller.	Check discharge and suction pressure for Refrigerant leak. Check Blower wire connections. Check Blower Capacitor. Replace Condenser Blower. Check Speed Controller Sensor. Replace Speed Controller.
Unit not cooling. (Temperature difference between return and supply air is less than 10°F). Evaporator Blower, Condenser Blower and Compressor are running.	Condenser or Evaporator Coil clogged. Loss of Refrigerant. Ice on Evaporator Coil. Excessive condensate draining and loss of A/C sensible cooling performance.	Clean Coil. Locate and repair leak. Clean Evaporator Coil. Check discharge and suction pressure for Refrigerant leak. Check for any obstruction of Evaporator airflow. Check and seal all openings. Eliminate the frequency of door openings.
Unit overcooling. Evaporator Blower, Condenser Blower and Compressor are running.	Failed Thermostat. Failed Relay.	Check Thermostat wire connections. Replace Thermostat. Replace Relay.
Compressor cycling more than 10 cycles per hour.	Short circuiting of air between A/C discharge and inlet openings.	Provide baffle in the enclosure separating A/C Outlet and inlet.
Excess vibration.	Defective motor in Blower. Defective wheel in Blower. Bad Compressor.	Replace motor. Replace wheel. Replace Compressor.

X. Standard Warranty

KOOLTRONIC products are warranted to be free of defects in workmanship, materials and components. The following warranty periods apply from date of shipment:

- Air moving devices/components and hermetic system components: 1 year
- Spare parts, except filters: 90 days

The above warranty applies when the equipment is operated under the following conditions:

- Ambient temperature not in excess of 125°F (52°C) in normal atmosphere or as stated on product nameplate
- Voltage variation no greater than $\pm 10\%$ from nameplate rating
- Frequency variation no greater than $\pm 3\text{Hz}$ from nameplate rating
- Maximum cooling load no higher than air conditioner nameplate rating
- Waiting five minutes before restarting air conditioner after intentional or accidental shutoff
- Compliance to all other installation, maintenance and operating instructions, as supplied
- The purchaser assumes the responsibility of grounding the unit and installing it in accordance with local electrical and safety codes, as well as the National Electric Code (NEC) and OSHA

KOOLTRONIC cannot assume responsibility for mis-application of its products or the erroneous selection of an inappropriate product by a non-authorized KOOLTRONIC representative. Our applications engineers will gladly assist in the selection of the proper product, provided all required details of the application are furnished.

THIS WARRANTY CONSTITUTES THE ENTIRE WARRANTY WITH RESPECT TO THE PRODUCT AND IS IN LIEU OF ALL OTHERS, EXPRESSED OR IMPLIED, INCLUDING ANY WARRANTY OF MERCHANTABILITY AND WARRANTY OF FITNESS FOR A PARTICULAR PURPOSE AND IN NO EVENT IS KOOLTRONIC RESPONSIBLE FOR ANY CONSEQUENTIAL DAMAGES OF ANY NATURE WHATSOEVER.

RETURN AUTHORIZATION (RA) PROCEDURE

- All returns require a Return Authorization number whether the return is for warranty or non-warranty repair, rotation of stock, damage or any other reason. Returns without an RA number will be refused.
- Customer must call KOOLTRONIC After Sale Kare (ASK), Pennington, New Jersey (609 • 466 • 3400) to obtain an RA number, or email ask@kooltronic.com.
- The following information is required when an RA is requested:
 - Original customer Purchase Order number and date
 - Date product was received by customer
 - Number of parts to be returned
 - Product description, model and serial number
 - Reason for return
 - Action requested
 - Contact name, telephone, FAX numbers and e-mail address
- Pack unit in a suitable container for shipment, preferably the

KOOLTRONIC assumes no liability beyond the repair or replacement of its own product. This Warranty does not cover:

- Labor or reimbursement of labor for evaluation, removal, installation, repair, or cost of any warranted part, unless authorized in writing by KOOLTRONIC
- Use of equipment for other than its designed purpose or operating conditions
- Operation in harsh, oily, corrosive or other abnormal environmental conditions, without the proper filtration, sealing, protective coatings and/or weather protection
- Damage to hermetic system resulting from continuous operation with dirty or clogged air filters or improper or negligent maintenance
- Use of refrigerant other than designated
- Customer modification or abuse
- Shipping damage or other accident (Claims for shipping damage are the responsibility of the customer. Timely claims must be filed by the customer with the freight carrier)
- Cracked or broken hermetic tubing, brazed joints or other internal damage caused by shipping or mishandling
- Damage caused by shipping units attached to an enclosure
- Any and all conditions resulting from noncompliance with the preceding operating conditions
- Returned freight must be paid by customer
- **This standard warranty does not apply to custom products. Consult your KOOLTRONIC representative for limitations**

original packaging if available. All Air Conditioners must be returned in an upright position properly secured to a pallet. **Improper packaging may void warranty claim.** If an Air Conditioner is received laying down or shipped via UPS or similar small parcel service the warranty will be void.

- Mark carton prominently with KOOLTRONIC's Return Authorization Number.
- Enclose all pertinent documents.
- Freight charges on all products returned to KOOLTRONIC shall be paid by the customer. Unauthorized collect shipments will be refused.
- If a unit is repaired under Warranty, KOOLTRONIC will pay the freight charges both ways within the Continental USA at KOOLTRONIC's negotiated rates. Warranty repaired units will be returned to customer at KOOLTRONIC expense only within the Continental USA.
- All authorized returns are subject to a restocking fee.