

TECHNICAL DATA

Model	CFM@ 0" S.P.	Cutoff S.P.	DC Volts	Amps	Watts	RPM	dBA	Min. Temp.	Max. Temp.
K8BCE225/63B	714	2.34	48	2.43	116	2335	68	-4°F/-20°C	158°F/70°C

STANDARD FEATURES

- Low noise level
- 714 CFM capacity
- Compact size
- Nominal voltage 48VDC (36-60VDC)
- Precision balanced
- External rotor design
- Precision ball-bearing motors
- Reverse polarity protection
- Soft start
- Locked rotor protection
- Tachometer output (open collector)
- Controlled by 0-10VDC or PWM signal

PERFORMANCE

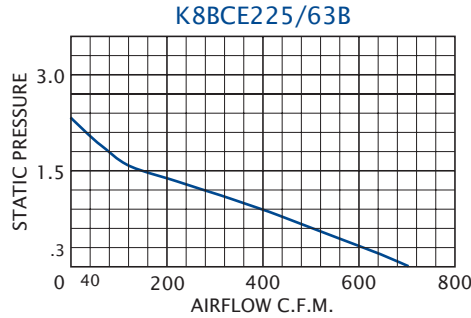

DRAWINGS

Dimensions, inches [mm], are for reference only and are subject to change.

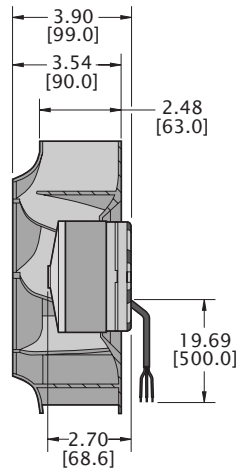
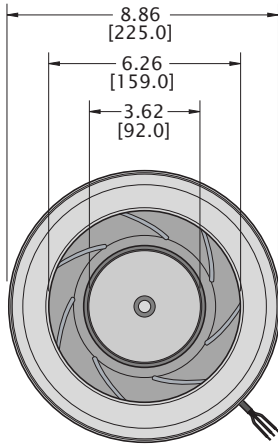

An inlet ring, which must be installed by the customer, is recommended for optimum performance.

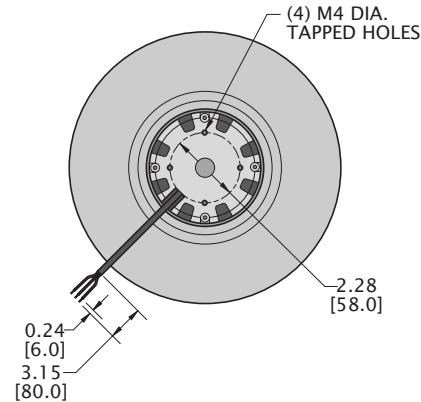

OPTIONAL INLET RING P/N: 1114-07

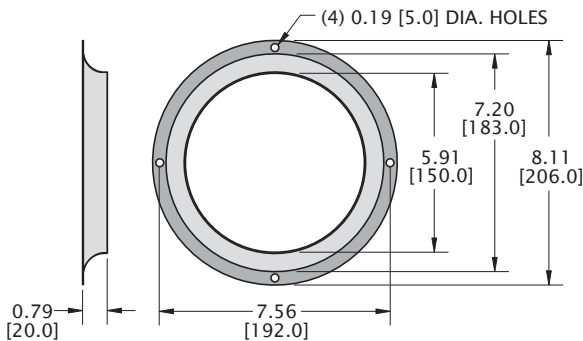

TYPICAL INSTALLATION

