



KXRP33 INDOOR/OUTDOOR AIR-TO-AIR PANEL-MOUNTED HEAT EXCHANGERS



TECHNICAL DATA*

Model	Normally in Stock	Volts	Power		Maximum Temperature °F		Performance Watts/°F (Air In)	Approx. Weight (lbs.)
			Amps	Watts	Enclosure	Ambient		
KXRP33	Yes	115	2.25	260	160	-20 to 131	30	48
K2XRP33		230	1.00	225	160	-20 to 131	30	48

STANDARD FEATURES

- Closed-Loop Near-Ambient Cooling
- Epoxy-Coated Convuluted Aluminum Element
- Heavy-duty Steel Shell
- NEMA 12 & 3R Ratings Maintained (UL50)
- Refrigerant-Free Aluminum Element
- UL/CUL Listed

ACCESSORIES AND OPTIONS

- Enclosure Heater
- Filter
- Filter Recoating Adhesive
- Other voltages and frequencies
- Replacement Filters
- Special materials or finishes
- Special motors, line cords or connectors



NEMA TYPE 12 & 3R MAINTAINED



PERFORMANCE*

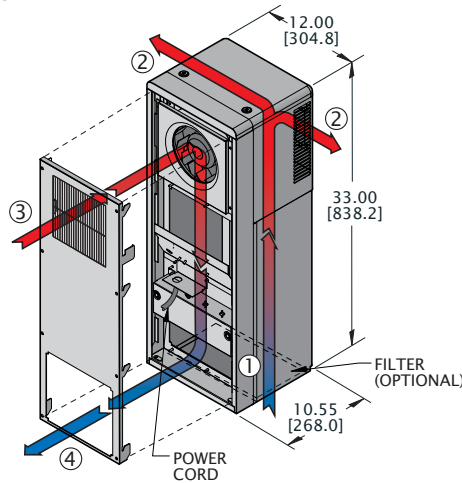
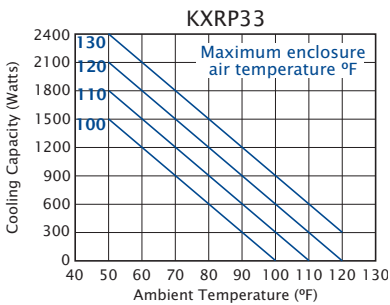

- ① CONDENSER AIR INLET (Ambient Air In)
- ② CONDENSER OUTLET (Warm Ambient Air Out)
- ③ WARM AIR RETURN FROM ENCLOSURE
- ④ COOL AIR OUTLET TO ENCLOSURE

MOUNTING PLAN

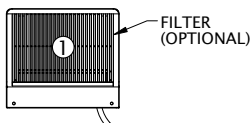
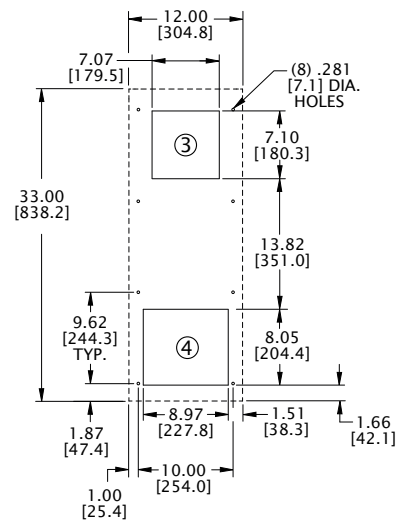
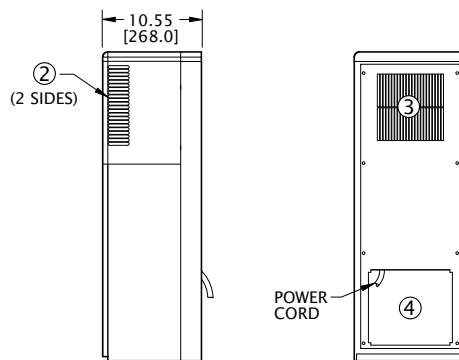
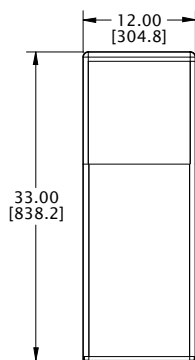

Dimensions, inches [mm], are for reference only and subject to change.

* 60 Hz. operation. For 50 Hz. operation, consult Kooltronic.

kxrp33.qxd 8/25/17

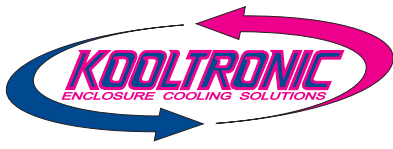

KXRP33 INDOOR/OUTDOOR AIR-TO-AIR PANEL-MOUNTED HEAT EXCHANGERS

DESCRIPTION

At last - heat exchangers designed specifically for cooling electronic enclosures that can be used for both indoor and outdoor applications right out of the box!

No more bulky unattractive weather hoods... No more worries over what options to specify for outdoor applications.

Expertly designed and crafted, the **ADVANTAGE Series** boasts a stylish appearance with rounded edges, no visible hardware and a baked powder finish to blend easily with contemporary enclosure designs.

Serviceability has been made easier by incorporating a "knock-down" sheetmetal design which provides quick access to internal components.

Standard features include heavy duty galvanized steel construction with baked-on powder paint and epoxy-coated heat exchanger element.

KOOLTRONIC also designs and manufactures a variety of Heat Exchangers to meet *unique* specifications. We invite your inquiries about our modification and custom-design capabilities.

STANDARD FEATURES

CLOSED-LOOP COOLING: The enclosure interior airflow system is isolated from the ambient airflow system. No ambient air can invade the cool, dehumidified sensitive component compartment.

PRECISION BALL-BEARING MOTORS: All blower motors are UL/CSA Recognized and include automatic-reset thermal overload protection and double-sealed or double-shielded precision ball bearings. Special permanent lubricants perform over a broad temperature range: -20°F [-28.9°C] to 250°F [121.1°C]. Consult KOOLTRONIC for motors designed to meet military or other extreme environmental specifications.

BLOWERS: All centrifugal blowers are Kooltronic-designed and built, to provide optimum airflow and pressure for each Heat Exchanger design.

EPOXY-COATED ELEMENT: Fabricated to the same standards as the uncoated convoluted aluminum elements, these are made from epoxy-coated aluminum stock that passed 1000 hour salt spray testing.

BAKED POWDER FINISH: Durable, baked-on polyester powder finish is standard. Other finishes are available.

RUGGED CONSTRUCTION: Precision-engineered heavy gauge steel construction of all internal structures and blowers insures Heat Exchangers will stand up under tough applications.

POWER: Available in 115 VAC, 60 Hz or 50/60 switchable and 230 VAC, 50 Hz or 60 Hz.

POWER CORD: All 115 and 230VAC models are supplied with six-foot three-wire cord with plug. BLDC units have three-wire cords without plugs for direct wiring to power source. Special lengths and/or plugs are available.

GASKETING: All units are fully gasketed for tight, leakproof installation, in compliance with the NEMA 3R Enclosure Rating.

UL/CUL LISTED: All **KXRP33** models are **UL/CUL Listed**.

ACCESSORIES AND OPTIONS**

FACTORY-INSTALLED OPTIONS:

ALUMINUM SHELL: Where light weight and/or compatibility with appearance of Aluminum Enclosures are required. Unpainted Type 5052 is standard. Other types and ultra-violet-resistant baked powder finish are available.

Append letter "A" to Part No. (5052 Unpainted)

ENCLOSURE HEATER - 120V or 240V fin strip heater, ambient blower thermostat, heater thermostat and heater limiter thermostat used to maintain desired internal enclosure temperature, under cold operating conditions. All of the thermostats are installed in the discharged enclosure air stream. When the enclosure discharge air goes below 70°F, the ambient blower thermostat shuts off the ambient blower. The blower is turned back on when the discharge air reaches 85°F. When the discharge air goes lower than 40°F, the heater thermostat turns on the heater and turns it off when the discharge enclosure air goes above 60°F.

Append letter "F" to Part No.

OTHER VOLTAGES AND FREQUENCIES**

SPECIAL MATERIALS OR FINISHES**

SPECIAL MOTORS, LINE CORDS OR CONNECTORS**

STAINLESS STEEL CABINET: For applications in corrosive or other hostile environments such as those requiring Internal Corrosion Resistant Coatings, especially where chemical/moisture combinations are present.

Append letter "V" to Part No. (304-2B Unpainted)

CUSTOMER-INSTALLED OPTIONS:

FILTER RECOATING ADHESIVE: This compound is a superior product for recoating filters after washing. The adhesives penetrate dirt layers to keep the filter surface tacky for longer effective performance between washings.

Part No. A-16 - 10 ounce container.

REPLACEMENT FILTERS: All KOOLTRONIC filters consist of a multi-layer grid of sturdy corrugated aluminum, securely held in a one-piece aluminum frame. Filters are required wherever air is drawn into an electronics enclosure or related cooling equipment to keep internal parts as clean as possible.

A non-drying adhesive coating traps a high percentage of particulate matter. These filters are reusable, they may be washed and recoated with the appropriate filter recoating adhesive. Replacements are available for those which become damaged or otherwise non-serviceable.

Optional Filter Part No. 7131F (7.50" x 11.50" x 0.38" [191mm x 292mm x 10mm])

**Contact KOOLTRONIC for information.