

NP/NPT47 TRIMLINE AIR-COOLED PANEL-MOUNTED CONDITIONERS

Legacy products are no longer in normal production. Consult factory for availability. Recommended replacement: See *Guardian/GuardianX* or *SlimKool Series*.



NPT47

NP47

TECHNICAL DATA

Model	NEMA Rating	UL/CUL Listed or Recognized	BTU/H Capacity	95/95 Rating BTU/H	Ambient Temp		Volts	Hz	Running Amps	Approx. Weight	
					°F Max./Min.	°C Max./Min.				lbs	kg
KA4C7NP47R	12	Recognized	7000	4750	125/50	52/10	115/110	60/50	16.5	150	69
K2A4C7NP47L	12	Listed	7000	4750	125/50	52/10	230/200	60/50	8.6	150	69
KA6C10NPT47L	3R & 12	Listed	10000	8300	131/-40	55/-40	115	60	19.4	128	59
KA6C10NPT47L	3R & 12	Listed	10000	7730	131/-40	55/-40	115	50	18.4	128	59
K2A6C10NPT47L	3R & 12	Listed	10000	8300	131/-40	55/-40	230	60	8.7	128	59
K2A6C10NPT47L	3R & 12	Listed	10000	7730	131/-40	55/-40	208	60	9.9	128	59
K2A6C10NPT47L	3R & 12	Listed	10000	7730	131/-40	55/-40	230	50	8.9	128	59
K2A6C13NPT47L	3R & 12	Listed	13000	9700	131/-40	55/-40	230	60	11.7	131	60
K2A6C13NPT47L	3R & 12	Listed	13000	8770	131/-40	55/-40	208	60	13.0	131	60
K2A6C13NPT47L	3R & 12	Listed	13000	8770	131/-40	55/-40	230	50	12.7	131	60

Rating shown is for operation at maximum ambient temperature.



STANDARD FEATURES

- Built-in Condensate Evaporator
- CFC-Free Refrigerant (NP Series)
- Closed-Loop Cooling
- Condenser Impeller Controller
- Filter
- High-Pressure Limiter Switch
- Low Temperature Control Thermostat
- NEMA 12 & 3R Ratings Maintained (UL50)**
- UL/CUL Listed or Recognized***
- Zero ODP Refrigerant (NPT Series)

** NPT47 models Maintain NEMA 12 & 3R Ratings. NP47 models Maintain NEMA 12 Rating.

*** NPT Series models are UL/CUL Listed. NP Series models are Listed or Recognized. Recognized models are available as Listed at added cost.

ACCESSORIES AND OPTIONS

- Compressor Short Cycle Protector
- Enclosure Heater
- Filter Recoating Adhesive
- High-Capacity Condensate Evaporator
- Internal Corrosion Protection
- Remote Thermostat Relay
- Replacement Filters
- Special controls or indicators
- Special materials or finishes
- Special motors, line cords, or connectors
- Stainless or Aluminum Shell
- Temperature Alarm
- Weather Protection Kit

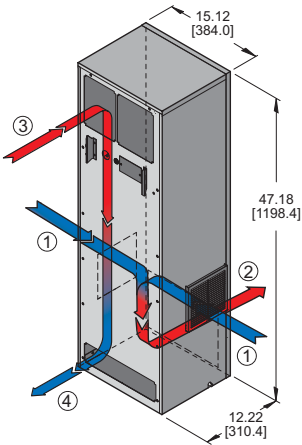

NPT47

Many popular units are available as 3D solid models for customer system integration. Please contact Kooltronic for details.

- ① CONDENSER AIR INLET (Ambient Air In)
- ② CONDENSER OUTLET (Warm Ambient Air Out)
- ③ WARM AIR RETURN FROM ENCLOSURE
- ④ COOL AIR OUTLET TO ENCLOSURE

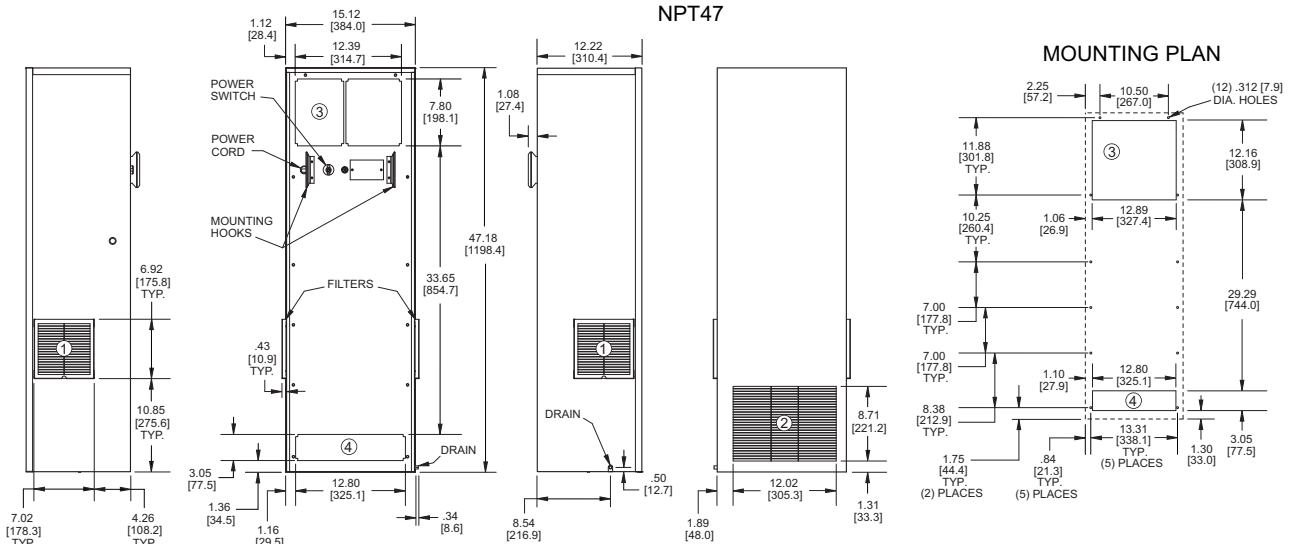

Dimensions, inches [mm], are for reference only and subject to change.

npt47.qxd (10/29/21) (CDR: 20369)

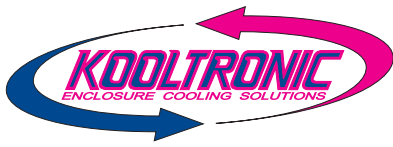

NP/NPT47 TRIMLINE AIR-COOLED PANEL-MOUNTED CONDITIONERS

PERFORMANCE CHARTS

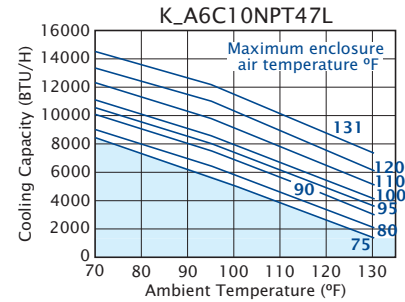
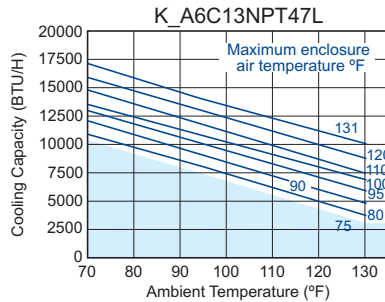
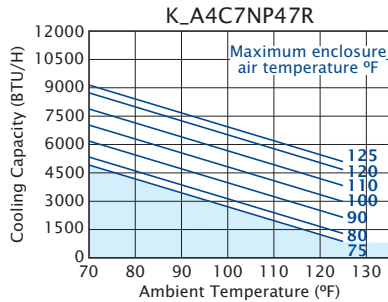

Operation within shaded areas not recommended.

DESCRIPTION

Innovations in technology have resulted in much denser components packaging and smaller available panel sizes on which to mount air conditioners. The KOOLTRONIC *TrimLine Series* is the response to these new packaging demands with the narrow width panel-mount air conditioners. In addition to being more narrow than traditional air conditioner units, the *TrimLine Series* include the Condensate Evaporator and Low Temperature Control Thermostat as standard features and are available in all popular voltages and frequencies.

The *TrimLine NP/NPT47 Series* is comprised of three units with capacities of 7,000 and 13,000 BTU/H. These compact models are designed with a minimum width to take up less cabinet space on the exterior panel or door. The *NP/NPT47 Series* models are NEMA Type 12 and 3R Maintained (UL50).

Outdoor or corrosive environments require weather protection and/or special internal and external protective features. Also see *Guardian/GuardianX Series, Advantage Indoor/Outdoor* and *Intrepid Outdoor Series*.

For extreme ambient temperatures and/or severely contaminated environments, the use of *TrimLine* or other *Water-Cooled Air Conditioners*, or the *GuardianX Series* is recommended.

KOOLTRONIC also designs and manufactures a variety of Air Conditioners to meet unique specifications. We invite your inquiries about our modification and custom-design capabilities.

STANDARD FEATURES

BAKED POWDER FINISH: Durable, baked-on gray powder finish is standard. Other finishes are available.

BALL-BEARING MOTORS: All blower motors are UL/CSA Recognized and include automatic-reset thermal overload protection and double-sealed or double-shielded precision ball bearings. Special permanent lubricants perform over a broad temperature range: -20°F [-28.9°C] to 250°F [121.1°C].

BLOWERS: All centrifugal blowers are Kooltronic-designed and built, to provide optimum airflow and pressure for each air conditioner design.

CLOSED-LOOP COOLING: The enclosure interior airflow system is isolated from the ambient airflow system. Ambient air can not invade the cool, dehumidified sensitive component compartment.

CONDENSATE EVAPORATOR: Built-in Condensate Evaporator eliminates need for draining condensate under normal operating conditions. May not be adequate in extremely high humidity with open or leaky enclosure. Overflow condensate drain fitting and hose are included.

CONDENSER IMPELLER CONTROLLER: Utilizes a discharge pressure switch. At low ambient temperature the refrigerant discharge pressure drops below the pressure switch point, shutting the Condenser Impeller off. When the discharge pressure rises above the set point, the pressure switch contacts close, starting the Condenser Impeller.

FILTERS: Multi-layer grid of sturdy, corrugated aluminum in an aluminum frame. May be reused after washing off accumulations and spraying with A-16 Recoating Adhesive.

GASKETING: *TrimLine NPT47* are fully gasketed for tight, leakproof installation, in compliance with the NEMA 12/3R Enclosure Ratings. *TrimLine NP47* are fully gasketed for tight, leakproof installation, in compliance with the NEMA 12 Enclosure Rating.

INSULATION: All cold components, lines and the evaporator compartment are insulated with high-performance insulation for maximum efficiency.

LOW TEMPERATURE CONTROL THERMOSTAT: Prevents over-cooling and provides energy-efficient operation.

POWER: Available in 115/100 VAC, 60/50 Hz, 230/200 VAC, 60/50 Hz, 230 VAC 60 or 50 Hz and 208 VAC 60 Hz.

POWER CORD: All models have six foot [1.8m] 3-wire power cord. Those rated at 16.0 Amps or less are supplied with appropriate plugs. Those rated at more than 16.0 Amps are supplied without plugs, for direct wiring to power source.

QUALITY ASSURANCE: Refrigeration system components are kept sealed until charged with refrigerant; all brazed joints are thoroughly leak-tested; each unit is functionally tested before shipment.

REFRIGERANTS: All *TrimLine NPT47 Series* Air Conditioners contain Zero Ozone Depleting Potential (ODP) R410a Refrigerant. All *TrimLine NP47 Series* Air Conditioners contain CFC-free R134a Refrigerant.

RUGGED CONSTRUCTION: Precision-engineered heavy gauge steel construction of all shells and blowers insures air conditioners will stand up under tough applications.

UL/CUL LISTED: All *TrimLine NPT47 Series* models are *UL/CUL Listed*. All *TrimLine NP47 Series* models are *UL/CUL Listed* or *Recognized*. All *Recognized* models are available as *Listed* at added cost.

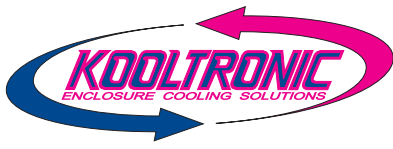

NP/NPT47 TRIMLINE AIR-COOLED PANEL-MOUNTED CONDITIONERS

ACCESSORIES AND OPTIONS**

FACTORY-INSTALLED OPTIONS:

ALUMINUM SHELL: Where light weight and/or compatibility with appearance of Aluminum Enclosures are required. Unpainted Type 5052 is standard. Other types and ultra-violet-resistant baked powder finish are available.

Append letter "A" to Part No. (5052 Unpainted)

COMPRESSOR SHORT CYCLE PROTECTOR: Protects the compressor from possible damage due to harmful short cycling.

Append letter "Y" to Part No.

ENCLOSURE HEATER: 120V or 240V fin strip heater, installed singly or ganged, used to maintain desired internal enclosure temperature, under cold operating conditions.

Single Heater, append letter "F" to Part No.

Double Heater, append letter "G" to Part No.

INTERNAL CORROSION PROTECTION: For corrosive or other hostile environments, special coating material is applied to copper lines, coils and other parts subject to damage. Also see **Stainless Steel Shell, Guardian/GuardianX or Integrity NEMA 4/4X Air Conditioners.**

Append letter "H" to Part No.

LOW AMBIENT KIT: Maintains sufficient operating pressures when ambient temperatures drop below 50°F [10°C]. Includes a compressor heater and pressure actuated condenser blower cycling control.

Append letter "N" to Part No.

SPECIAL MATERIALS OR FINISHES**

SPECIAL MOTORS, LINE CORDS OR CONNECTORS**

STAINLESS STEEL SHELL: For applications in corrosive or other hostile environments such as those requiring Internal Corrosion Resistant Coatings, especially where chemical/moisture combinations are present.

Append letter "V" to Part No. (304-2B Unpainted)

TEMPERATURE ALARM: A thermostat is mounted inside the cabinet and attached to a sensor in the warm air return. When the air temperature increases to the set point, a signal is sent to a terminal block. User-installed wiring from the terminal block to local and/or remote warning devices (*light, bell, siren, etc.*) can be for normally open or closed operation.

Append letter "B" to Part No.

CUSTOMER-INSTALLED OPTIONS:

FILTER RECOATING ADHESIVE: This compound is a superior product for recoating filters after washing. The adhesives penetrate dirt layers to keep the filter surface tacky for longer effective performance between washings. Part No. A-16.

REPLACEMENT FILTERS: All KOOLTRONIC filters consist of a multi-layer grid of sturdy corrugated aluminum, securely held in a one-piece aluminum frame. Filters are required wherever air is drawn into an electronics enclosure or related cooling equipment to keep internal parts as clean as possible.

A non-drying adhesive coating traps a high percentage of particulate matter. These filters are reuseable, they may be washed and recoated with the appropriate filter recoating adhesive. Replacements are available for those which become damaged or otherwise non-serviceable.

For **NPT47 Series** models the replacement filter Part No. is 681F (6.80" x 6.80" x .38" [172.7mm x 172.7mm x .97mm]) Two filters are required.

For **NP47 Series** models the replacement filter Part No. is 12251F (16.63" x 11.88" x .50" [422.4mm x 301.8mm x 12.7mm])

**Contact KOOLTRONIC for information.

KOOLTRONIC also designs and manufactures a variety of Air Conditioners to meet *unique* specifications. We invite your inquiries about our modification and custom-design capabilities.

HOW TO ORDER

Specify model number. NOTE: Accessories and Options may affect model number, contact KOOLTRONIC for information.

For assistance in model selection, refer to the [Air Conditioner Sizing and Selection Guide](#), contact KOOLTRONIC, or use one of our design aid software programs, available FREE.

CALL 1-800-321-KOOL (5665)
or FAX 609-466-1114

POPULAR MODELS ARE
STOCKED AND READY TO SHIP



Find additional information on this model at kooltronic.com, or use the Technical Documents QR code below.

Technical Documents

