

KBR100 HIGH PRESSURE RADIAL BLOWER



ACCESSORIES AND OPTIONS

- Airflow Switch
- Automatic Speed Control
- Other voltages and frequencies
- Special external paint finishes
- Special line cord or connectors

STANDARD FEATURES

- Capacity: 215 CFM
- Designed for substantial static pressures
- Full performance in any mounting position
- Rugged construction with baked powder finish
- UL/CSA ball bearing motors
- 12-inch [304.8mm] (minimum) power and ground leads
- Accessories and options

PERFORMANCE GRAPH

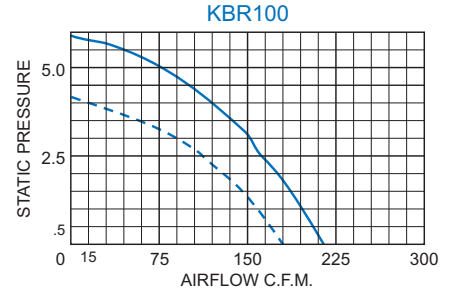

Airflow vs. static pressure curves are shown for 60 Hz and 50 Hz (broken line) inputs. Static pressure is in inches of water.

Find additional information on this model at kooltronic.com, or use the Technical Documents QR code below.

Technical Documents



TECHNICAL DATA*

Model	CFM @ 0" S.P.	Cutoff S.P.	RPM Nominal	Amps		Watts	Approximate Weight	
				Run.	L.R.		Lbs.	Kg.
KBR100	215	6.00	3450	3.1	8.1	315	15	6.8

Note: Power input is substantially reduced at higher static pressures.

* 115V, 60 Hz. operation

DIMENSIONS inches [metric]

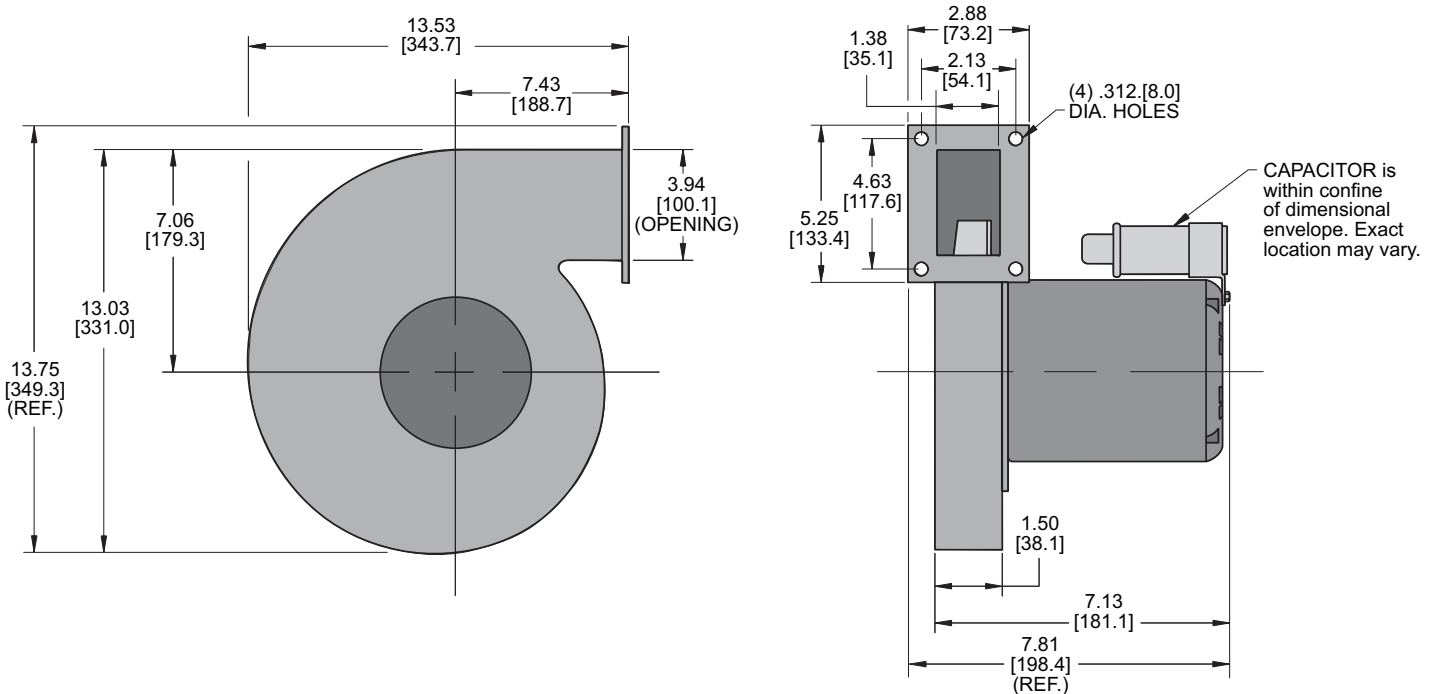

Dimensions, inches [mm], are for reference only and subject to change.

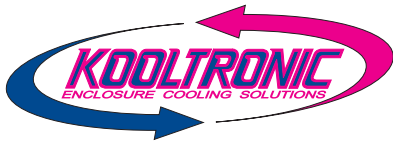

KBR100 HIGH PRESSURE RADIAL BLOWER

DESCRIPTION

This series of blowers was specifically designed for maximum efficiency in the movement of moderate volumes of air against substantial static pressures. Applications include cooling computer disk drives, densely-packed enclosures, forcing gas-air mixtures into small boiler combustion chambers, and in chromatography and pollution sampling equipment, to name just a few.

High Pressure Radial Blowers are available in a choice of sizes and capacities, ranging from 40 CFM to 240 CFM at 1" [24.5mm] static pressure and up to 150 CFM at 5" [127.0mm] static pressure. Consult performance graphs for airflows available at your static pressure requirements.

STANDARD FEATURES

RUGGED CONSTRUCTION: Precision-engineered heavy-gauge steel construction insures blowers stand up under tough applications.

BAKED POWDER FINISH: Durable, baked-on gray powder finish is standard. Other finishes are available.

PRECISION BALL-BEARING MOTORS: All motors, whether permanent split capacitor or shaded pole, are UL/CSA Recognized and include automatic-reset thermal overload protection. Designed for low temperature rise, KOOLTRONIC motors are also cooled by the blowers' intake air, for maximum motor life. All motors meet Federal Specification CC-M-1807A, and include double-sealed or double-shielded precision ball bearings, which meet Federal Specification FF-B-171A. Special permanent lubricants perform over a broad temperature range: -20°F (-28.9°C) to 250°F (121.1°C). Consult KOOLTRONIC for motors designed to meet military or extreme environmental specifications.

POWER: 115 VAC or 230 VAC, 50/60 Hz is standard. For multi-phase power, other voltages and frequencies or brushless DC applications, consult KOOLTRONIC. **NOTE:** Some 230 Volt models may not be available or minimum purchases may apply. Contact Kooltronic for information.

LEADS: 12" [304.8mm] (minimum) power and ground leads. Special lengths and/or plugs available.

ACCESSORIES AND OPTIONS*

AIRFLOW SWITCH: Protects equipment against damage caused by loss of cooling airflow by activating an alarm or turning off power. The switch can be mounted on any suitable surface which allows the stainless steel air vane to be placed in the critical airstream. This switch is a single-pole double-throw type, with normally open and normally closed contacts. To order integrated airflow switch add -XX10 to model number. To order as external accessory, see Kooltronic website.

OTHER VOLTAGES AND FREQUENCIES

SPECIAL EXTERNAL PAINT FINISHES

SPECIAL LINE CORDS OR CONNECTORS

*Contact KOOLTRONIC for information.

KOOLTRONIC also designs and manufactures a variety of Blowers to meet *unique* specifications. We invite your inquiries about our modification and custom-design capabilities.