

KP4E195/35 PAGODA SERIES PACKAGED IMPELLER BLOWERS

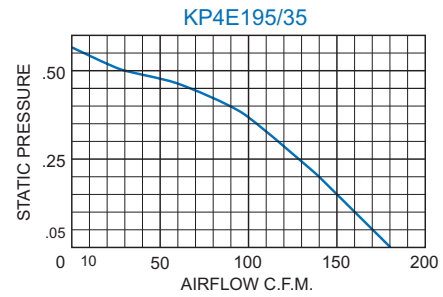

PERFORMANCE GRAPHS



STANDARD FEATURES

- Baked Powder Finish
- Capacity 180 CFM
- Compact size
- Occupies no internal cabinet space
- Low noise level
- Heavy-gauge steel enclosure
- Precision balanced external rotor design
- Integral finger guards
- Ball-bearing motors
- Three foot [0.9m] (minimum) 3-wire power cord

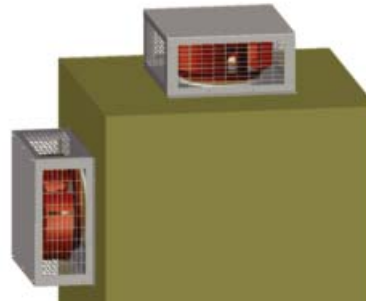

Versatile Mounting:
Mount on cabinet's top,
side or even bottom.

TECHNICAL DATA*

Model	Type	CFM @ 0" S.P.	Cutoff S.P.	Amps	Watts	Approximate Weight	
						Lbs.	Kg.
KP4E195/35	4-Pole	180	0.57	0.31	35	11	5.0

* 115V, 60 Hz. operation

DIMENSIONS inches [metric]

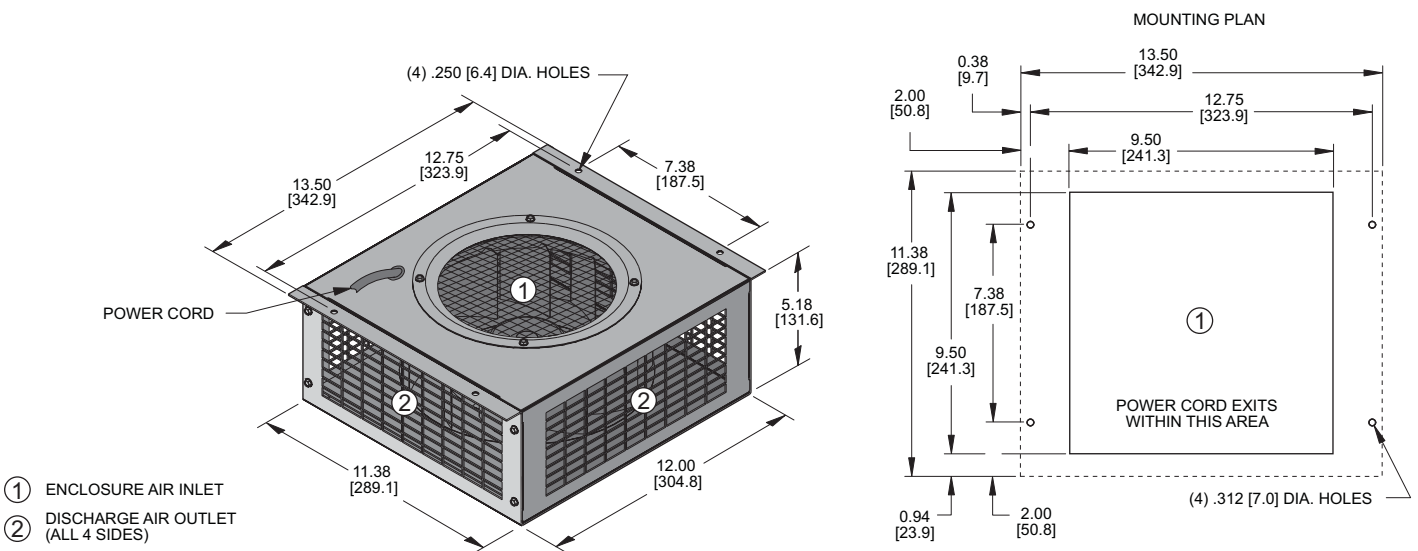

Dimensions, inches [metric], are for reference only and subject to change.

HOW TO ORDER

Specify model number. For 230 VAC operation, add a 2 after the K. Example: K2P4E195/35.

kp4e195/35 pagoda.qxd 1/14/16