



**NPT SERIES
K_A6C_NPT47L**

**Keep This Manual
With Air Conditioner**

Find additional information on this model at kooltronic.com, or use the Technical Documents QR code below.

Technical Documents



AIR CONDITIONER OPERATOR'S MANUAL

CAUTION

BEFORE INSTALLING AND USING THIS AIR CONDITIONER, IT IS IMPORTANT THAT THIS MANUAL BE READ AND UNDERSTOOD THOROUGHLY



KOOLTRONIC, INC.
30 Pennington-Hopewell Road
Pennington, NJ 08534
609•466-3400
FAX: 609•466-1114
www.kooltronic.com

TABLE OF CONTENTS

		Page
I.	Introduction	2
II.	Incoming Inspection	3
III.	Product Handling	3
IV.	Product Identification and Nameplate	4
V.	Principles of Operation	5
VI.	Pre-Installation Testing	6
VII.	Specific Model Data	7 - 10
	Mounting	
	Drawings and Dimensions	
	Technical Data	
	Major Component Replacements	
	Standard Features	
VIII.	Maintenance	11 - 12
IX.	Trouble Shooting	12 - 13
X.	Warranty	14

NOTE: Wiring Schematics are available on the specific model page of the Kooltronic website.

I. Introduction

Kooltronic Air Conditioners are designed to provide a cool, dehumidified environment for your electronic components. There are models to fit virtually all sizes and shapes of electronics enclosures, in capacities ranging from 1,000 to 30,000 BTU/H. Our "closed-loop" design also ensures that your components will not be exposed to hot, dirty operating conditions.

This Manual provides you with the necessary general information for properly installing and operating standard Kooltronic Air Conditioners. Technical data and mounting instructions are presented on pages 7 through 10.

II. Incoming Inspection

Kooltronic Air Conditioners are designed, built and packaged to withstand the shock and vibration normally associated with shipment by common carriers. Occasionally improper handling during shipping causes damage. Such handling could include unbanding of palletized shipments, failing to respect "**This Side Up**" arrows, rough handling, falling off conveyors, excessive vibration, crushing, etc. Therefore, a thorough inspection should be done upon receipt of all shipments. Any carton tears, dents, scratches, loose articles or evidence of oil are signs of damage and should be noted on the Freight Bill. Cartons should be opened promptly and the units inspected for CONCEALED DAMAGE. Kooltronic Air Conditioners must be delivered in the proper mounting position to assure that damage to the compressor has not occurred during shipping. Any Kooltronic Air Conditioner that is delivered removed from the banded pallet, lying down or double stacked should be refused.

An immediate claim **MUST** be filed with the freight carrier and an inspection requested. Retain all packing materials. Kooltronic cannot assume responsibility for Consignee's failure to file a timely freight claim.

III. Product Handling:

- 1) Do not attempt to operate your Kooltronic Air Conditioner until you read and thoroughly understand this Manual. See section **VI PRE-INSTALLATION TESTING**.
- 2) Before operating the Kooltronic Air Conditioner be certain that it is placed in its correct mounting position. **This Air Conditioner is designed to operate in a vertical position only.** This placement must be done a minimum of 5 minutes prior to operating in order to allow the compressor oil to drain to the compressor sump area.

CAUTION

Kooltronic Air Conditioners must be operated in their proper mounting position. If attempts are made to operate a unit that is not in its designed mounting position, permanent compressor damage will occur. This action will void the warranty. To avoid compressor damage do not tip the unit more than 45° from its proper mounting position.



- 3) Before operating this unit, all electrical wiring must be checked to assure the proper connection to the correct power source. Minimum circuit ampacity should be at least 125% of the amperage found on the nameplate for the corresponding voltage. Do not exceed the maximum fuse size found on the nameplate.
- 4) We do not recommend that Air Conditioners be shipped to their final destination attached to an enclosure. In the event that the Air Conditioner needs to be shipped attached to an enclosure it is strongly recommended that proper support be provided for the Air Conditioner. Excessive vibration can occur if Air Conditioners are not properly supported when shipped on enclosures, increasing the potential for internal damage and voiding the warranty.
- 5) **PROCEDURE FOR PROPER PACKING AND SHIPMENT OF KOOLTRONIC AIR CONDITIONERS:**
 - Keep Air Conditioner in proper upright position indicated by arrow markers.
 - Pack Air Conditioner in an appropriate carton (preferably original carton if possible), with adequate internal protective packaging, making sure carton is marked and is kept in correct upright position.
 - For local, controlled transportation, strap carton to a secure part of truck to prevent falling or sliding, minimize vibration, etc.
 - For common carrier shipment, band unit(s) securely to a pallet. Unpalletted shipment risks severe damage which voids the warranty.

IV. Product Identification and Nameplate

Each Kooltronic Air Conditioner includes an identification nameplate. This nameplate provides:

- ① Model Number
- ② Serial Number
- ③ Electrical power characteristics
- ④ Maximum and minimum ambient operating temperatures
- ⑤ Cooling capacity
- ⑥ Type and amount of refrigerant required for recharging
- ⑦ Design Pressure
- ⑧ Maximum Fuse Size
- ⑨ Manufacturing Order Number
- ⑩ Filter Part Number
- ⑪ Underwriters Laboratories Inc. Listed or Recognized Marks and NEMA ratings

We recommend you copy this information from your unit.

		Air Conditioner			
		MODEL NUMBER		SERIAL NUMBER	
①		②			
VOLTS	FREQ.	PH.	COOLING F.L.A.	AMBIENT TEMP. MIN.°F	MAX.°F
③	③	③	③	④	④
COOLING BTU		REFRIGERANT		Oz.	
⑤		⑥			
DESIGN PRESSURE P.S.I.G.		FUSE SIZE MAX.		 LISTED 84H7 SPECIAL PURPOSE AIR CONDITIONER	
LOW	HIGH				
⑦	⑦	⑧			
		MFG. ORDER NO.			
		⑨			
		FILTER P/N			
		⑩			
				⑪	
SPECIAL PURPOSE AIR CONDITIONER NEMA/EEMAC/UL50 BY UNDERWRITERS LABORATORIES, INC. TYPE 3R & 12 INTERFACE TO THE ELECTRICAL ENCLOSURE ONLY NEMA/EEMAC/UL50 BY UNDERWRITERS LABORATORIES, INC. TYPE 1 SPECIAL PURPOSE AIR CONDITIONER EQUIPMENT COMPARTMENT ONLY OUTDOOR USE SERVICE AIR FILTER REGULARLY ALLOW 5 MIN. BEFORE RESTARTING AFTER SHUTDOWN UNAUTHORIZED SERVICE OR MODIFICATION VIOLATES WARRANTY ALL MOTORS ARE THERMALLY PROTECTED					
MANUFACTURED BY: KOOLTRONIC, INC. PENNINGTON, NJ					



①②⑨ When ordering parts, specify the Model Number, Serial Number & MFG. Order Number.

③ Before operating, be sure that the power source matches these requirements.

④ Make sure that these parameters are met. Failure to do so may result in permanent damage to the unit.

⑥ Use of incorrect type or amount of refrigerant will adversely affect performance and may damage the unit.

V. Principles of Operation

Kooltronic Air Conditioners are required when the equipment operating temperature must be kept near or lower than the ambient room temperature, and/or the cabinet must be sealed from dust, fumes, oil, corrosives and other contaminants. These Air Conditioners utilize a "Closed-Loop Cooling System" to ensure optimum performance of the installed components.

Closed-Loop cooling seals the electrical enclosure from hostile elements in the environment. Two separate circulation systems are employed. The internal system cools and dehumidifies the air inside the cabinet, totally isolating the sensitive electronics and other components from the environment. The external system uses circulating ambient air or water to discharge the heat removed from the electronics. The heat is dissipated from the enclosure by means of the vapor compression refrigeration cycle. This takes place in a hermetically-sealed refrigeration system, utilizing either an air-cooled or water-cooled condenser heat exchanger. The warm air inside the enclosure is drawn through the evaporator coil where it is cooled, dehumidified and returned.

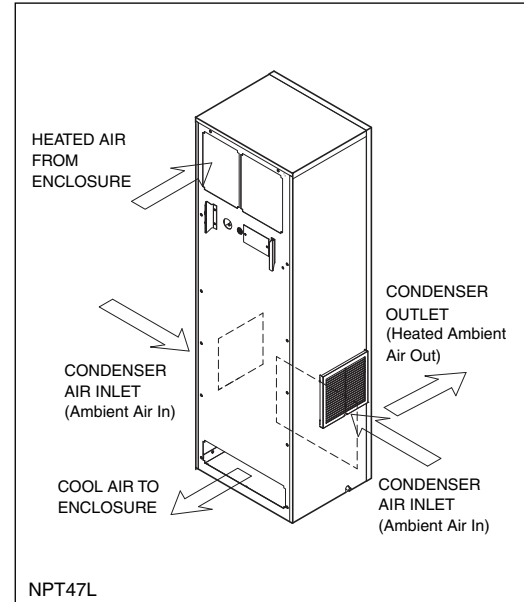

Any enclosure moisture accumulated on the evaporator coil is collected in the condensate tray and removed through the drain tube to the condensate evaporator. Condensate evaporates in the condensate evaporator and is released to the ambient air by the condenser impeller.

The heat removed through the evaporator coil is transferred by the compressed refrigerant to the condenser coil. Ambient air is then passed through the condenser coil, where it absorbs the heat and is then discharged to the environment.

This unit is equipped with a Low Temperature Thermostat to prevent the evaporator coil from freezing. In conditions of low ambient temperature and low enclosure load, the thermostat regulates the return air temperature from 75°F to 86°F. The standard set point of the Low Temperature Thermostat is 75°F. The set point can be changed to 70°F or to 79°F by changing the location of the thermostat jumper (See illustrations on page 8).

The Low Temperature Thermostat has a test start relay. When the air conditioner is turned on it will run constantly for the first 15 minutes regardless of external temperatures. Afterwards, if the entering evaporator air temperature is lower than the thermostat set point, the compressor and condenser blower will stop, and the thermostat will begin to control the air conditioner.

The heater kit consists of a heater, a heat control thermostat and a heater limiter. The heater control thermostat is a bimetal disk with a fixed set point of 60 F. When the entering evaporator air temperature rises above 60°F the heater shuts off, and when the evaporator air temperature falls below 40°F the heater will engage. The contact points of the alarm thermostat are normally closed. If the entering evaporator air temperature exceeds 130°F the alarm thermostat contacts open, and when the temperature drops below 130°F the contacts close.

A condenser impeller controller is standard on this unit. When the ambient temperature falls below 70°F the discharge pressure switch will cycle the condenser impeller. In applications having frequent voluntary heat load fluctuations, an optional Compressor Short Cycle Protector is recommended.

When the Kooltronic Air Conditioner is properly sized it should operate constantly and maintain 75°F to 115°F enclosure temperature, depending on the ambient temperatures.

VI. Pre-Installation Testing

Before mounting the air conditioner to the enclosure, test for proper operation. This will verify the shipping integrity of the system. Please follow the steps below prior to installation.

CAUTION

The air conditioner must be standing in its proper mounting position for a minimum of five (5) minutes prior to testing. Failure to follow this procedure will cause permanent damage to the compressor. To avoid compressor damage do not tip the unit more than 45° from its proper mounting position.

1. The unit must sit in an upright position at a minimum room temperature of 65°F to allow the system to warm up. This is particularly important during winter months.
2. Refer to the nameplate for proper electrical voltage and current requirements. Connect the power cord to a properly grounded and fused electrical supply, leaving electrical power to the unit turned off.
3. Note the factory thermostat setting which is 75°F.
4. Turn the electrical power on.
5. Verify that the evaporator blower or fan is running.
6. Condenser impeller should start immediately and after one (1) second, stop.
7. After three (3) to five (5) minutes the condenser impeller should start.
8. Verify that the condenser blower or fan is running.
9. Operate the air conditioner for approximately ten (10) minutes. During this period no unusual noise or vibration should be evident. Both the evaporator and condenser fans or blowers should be delivering air through their respective discharge ports. The cool air discharged should be less than 70°F when the room temperature is between 70°F and 80°F.
10. If ambient temperature is below 75°F, after fifteen (15) minutes the thermostat will shut off the compressor and the condenser impeller.
11. Turn off the electrical power and disconnect the air conditioner from the power source.
12. If any cover plug was removed to adjust the unit, be sure to replace it in order to maintain the integrity of the closed-loop airflow system.

NOTE: Before shipment all Kooltronic Air Conditioners are subjected to a performance test.

VII. Specific Model Data

Mounting

The Kooltronic Special Purpose Air Conditioners K_A6C_NPT47L have been engineered to be installed easily. Prior to mounting, refer to the mounting plan on page 8 showing dimensions and locations of mounting holes and cutouts. Prior to cutting or drilling, make sure that cutouts and mounting holes do not interfere with components inside the cabinet. To avoid damaging your air conditioner, please read the following information before installation:

- Install the two (2) mounting hooks using the four (4) supplied #10 screws, two screws for each hook.
- Refer to the mounting plan on page 8 for the location of all mounting holes and cutouts.
- Make sure the cutouts don't interfere with components inside your cabinet.
- Proper alignment of all air inlets and outlets is essential for optimum performance of the air conditioner.
- All externally-mounted air conditioners are fully gasketed to ensure proper sealing. This seal is necessary to maintain the integrity of the closed loop system.
- Hang air conditioner onto the enclosure.
- Secure the air conditioner to the enclosure using the supplied hardware.
- Use all existing mounting holes to insure stability and a tight seal.
- Attach supplied drain hose to the drain exit on the lower side panel of the air conditioner.
- The external drain hose must not be elevated above the exit port. Improper mounting will impede the flow of condensate and may cause internal malfunctions.

CAUTION

If the air conditioner is mounted to the cabinet door you must be sure that the door hinges will support the additional weight of the air conditioner. Also be certain that when the door is opened fully, the cabinet does not become unbalanced. The actual weight of the unit can be found in the performance specifications.

Drawings and Dimensions

MOUNTING PLAN

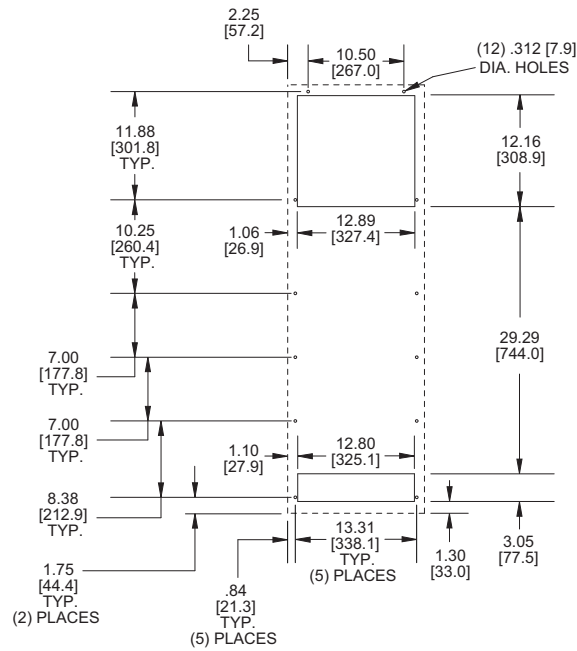

Dimensions, inches [mm], are for reference only and are subject to change.

ELECTRONIC THERMOSTAT CONTROL

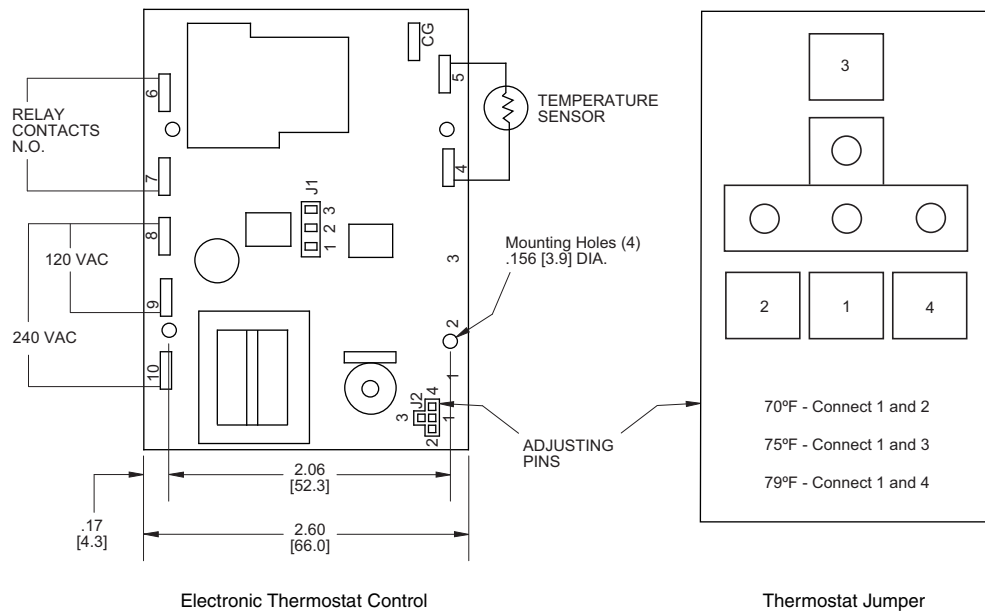

Dimensions, inches [mm], are for reference only and are subject to change.

Drawings and Dimensions

K_A6C_NPT47L

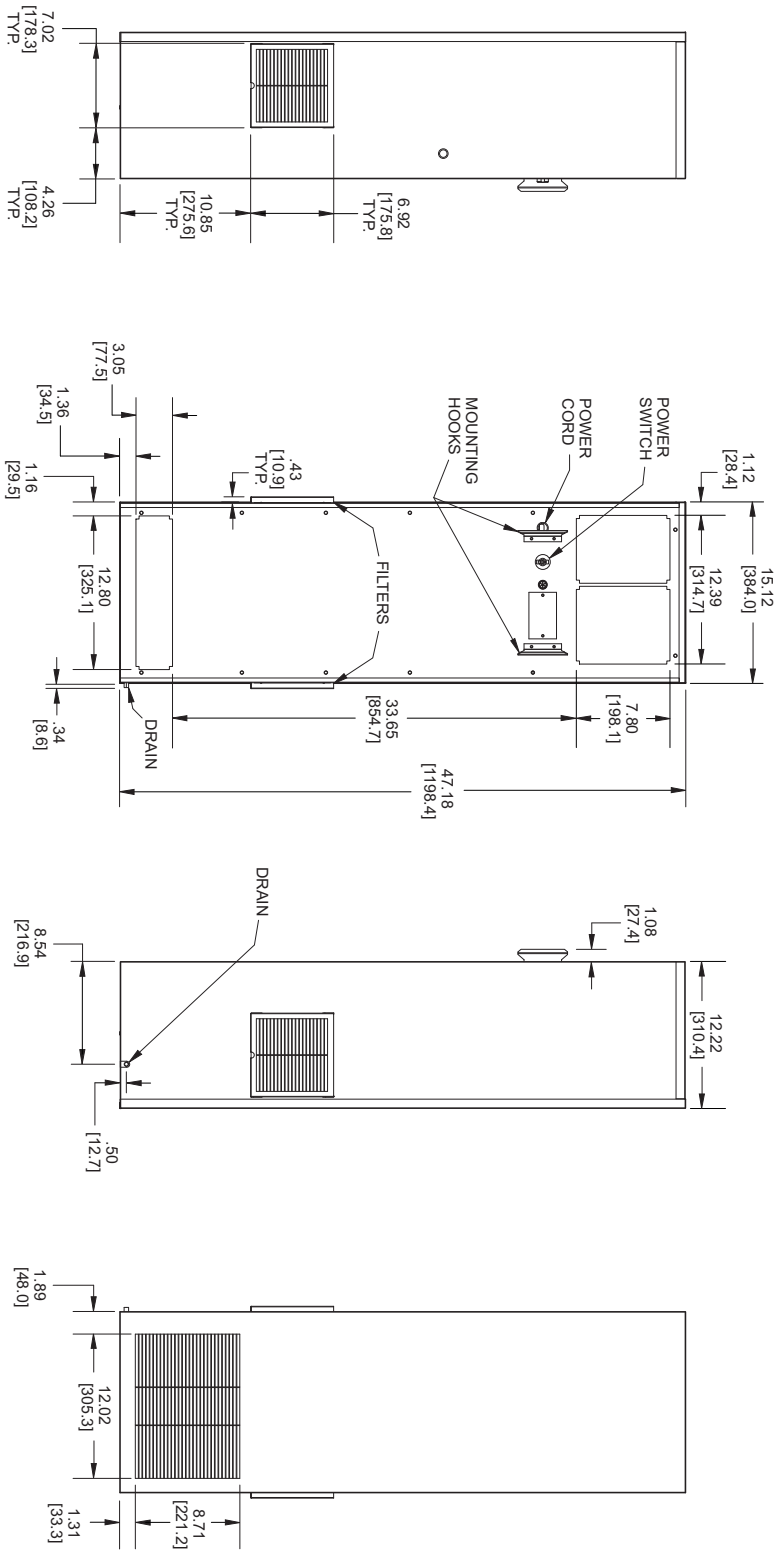
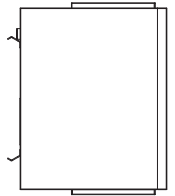

GAS4700A

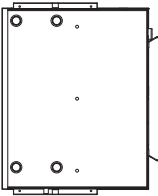

Dimensions, inches [mm], are for reference only and are subject to change.

Technical Data

Model	BTU/H Capacity	BTU/H 95°F/95°F	Ambient Temp. °F Max./Min.	Volts	Hz	Running Amps 131°F/131°F	Approximate Weight (lbs.)
KA6C10NPT47L	10000	8300/7730	131/-40	115	60/50	19.4/18.9	128
K2A6C10NPT47L	10000	8300/7730	131/-40	230	60/50	8.7/8.1	128
K2A6C13NPT47L	13000	9700/8770	131/-40	230	60/50	11.7/12.7	131

Major Component Replacements

Part	KA6C10NPT47L Part Number	K2A6C10NPT47L Part Number	K2A6C13NPT47L Part Number
Compressor	0665-409	0665-410	0665-412
Compressor Run Capacitor	0452-71	0452-52	0452-52
Condenser Blower Motor	0261-287	0261-288	0261-288
Condenser Motor Capacitor	0452-03	0452-03	0452-03
Evaporator Impeller	0194-87	0194-109	0194-109
Evaporator Impeller Capacitor	0452-06	0452-02	0452-02
Condenser Coil	0666-30	0666-30	0666-30
Evaporator Coil	0666-73	0666-73	0666-29

Standard Features

Built-in Condensate Evaporator
 Condenser Impeller Controller
 Filter
 High-Pressure Limiter Switch
 Low Temperature Control Electronic Thermostat
 Maintains NEMA 12/3R Rating (UL50)
 UL/CUL Listed
 Zero ODP Refrigerant

Accessories and Options

Compressor Short Cycle Protector
 Enclosure Heater
 Filter Recoating Adhesive
 High-Capacity Condensate Evaporator
 Internal Corrosion Protection
 Lead-Lag Controller
 Remote Thermostat Relay
 Replacement Filters
 Stainless or Aluminum Shell
 Temperature Alarm

VIII. Maintenance

Kooltronic Air-Cooled Air Conditioners require routine cleaning of the condenser coil (if necessary) and the air filters to assure unimpeded airflow through the condenser heat exchanger. It is not possible to recommend specific condenser coil or filter cleaning intervals, since the level and the nature of airborne particulate matter differs widely with each installation. It is generally sufficient to clean the condenser coil and/or the aluminum mesh filter when the outer surfaces appear covered with a thin layer of dust, lint or other foreign matter. The condenser coil can be washed or blown out with air, depending on the foreign matter involved (see below - **Filter and condenser coil service**). The aluminum mesh filter can be washed with warm water. Appropriate disposable replacement filters are available from Kooltronic.

If routine condenser coil or filter service is neglected or delayed, the air conditioner will not perform at its design capacity. The first indication of an excessively clogged condenser coil or air filter is usually a gradual increase of temperature within the equipment cabinet. If operation is continued under these conditions, the compressor will be shut off by the thermal overload device. The compressor will restart when its external temperature drops below the protector threshold setting and the compressor will continue to cycle on and off. Continued operation under these conditions will cause damage, shorten compressor life and void the warranty.

A. Filter and condenser coil service

The rear panel must be removed in order to clean the filters. After removal, the filters should be flushed under warm running water with clean side up. If the accumulated dirt is oily, washing in a detergent bath is recommended, followed by a warm water wash as above.

The exposed condenser coil must be cleaned by pressurized air or pressurized cleaning solution. Dirty liquid will be removed through the condenser coil drain pan.

B. Blowers

The design life of the blowers used in all Kooltronic Air Conditioners is substantially in excess of 20,000 hours. All Kooltronic condenser and evaporator blowers are equipped with automatic-reset thermal overload protectors.

CAUTION

Before opening the air conditioner, disconnect all power.

If field replacement of a blower motor is necessary, most blower assemblies, including the mounting plate, are readily removable. Each of the blower mounting plates is held to the air conditioner cabinet structure by screws and nuts. For installation of the replacement blower, electrical connections may be broken at the terminal block, or power leads may be cut and appropriately spliced together.

C. Compressor

All Kooltronic compressors are approved by UL and CSA, and require no maintenance. They are hermetically sealed and charged at the factory, and equipped with automatic-reset thermal overload protectors.

If the compressor fails, it is strongly recommended that the air conditioner be returned to Kooltronic for service.

D. Refrigerant Loss

Kooltronic Air Conditioners are subjected to a series of tests to detect refrigerant leaks, during and after manufacture. It is possible that shipping or other damage, or microscopic leaks over a long period, may result in the need for replenishment of refrigerant charge. **When it has been verified by a Certified EPA Technician that a refrigerant shortage does exist, the leak must be repaired. Then the unit may be evacuated and recharged in the field by a Certified EPA Technician only.**

CAUTION

Refer to the data on the unit nameplate which specifies the type of refrigerant and the amount of charge in ounces.

E. Relocation

If your Kooltronic Air Conditioner has to be moved to another location by truck, the following precautions should be taken:

- De-mount the air conditioner from the equipment, controller or enclosure.
- Conform to the applicable provisions of PROCEDURE FOR PROPER PACKING AND SHIPMENT OF KOOLTRONIC AIR CONDITIONERS in this manual under *Section III. "PRODUCT HANDLING"*.

IX. Trouble-Shooting

Each Kooltronic Air Conditioner is engineered for performance and built for reliability. They are designed to require only routine maintenance. If your air conditioner should require warranty service, please contact Kooltronic. If you require service out of warranty, we have compiled a trouble-shooting chart to assist your service personnel. If additional assistance is required contact Kooltronic at (609) 466-3400.

Problem	Cause	Solution
Unit does not run.	No Power.	Check Power Source and electrical connection. Check unit ON-OFF switch (UL Listed units only). Check unit power cord connection to terminal block.
After initial 15 minute energization of air conditioner, compressor and condenser fan do not run.	Return temperature is between Thermostat set point and differential (75°F to 86°F).	Normal Operation. Check return air temperature. Check sensor connection on Thermostat.
Unit not cooling. (Temperature difference between return and supply air is less than 10°F). Evaporator Blower is running. Compressor and Condenser Blower do not run. Return temperature is above set point plus differential (90°F).	Failed Thermostat or Relay. Low Line Voltage. Failed Compressor.	Check Thermostat and Relay wire connections. Replace Thermostat or Relay. Check Nameplate Voltage against supply Voltage. Check Compressor wire connections. Check Compressor overload. Check Compressor Capacitor. Replace Compressor.

Problem	Cause	Solution
Unit not cooling. (Temperature difference between return and supply air is less than 10°F). Compressor and Condenser Blower are running. Evaporator Blower does not run.	Failed Evaporator Blower.	Check Blower wire connections. Check blower capacitor. Replace Evaporator Blower.
Unit not cooling. (Temperature difference between return and supply air is less than 10°F). Compressor and Evaporator Blower are running. Condenser Blower does not run.	Low Refrigerant charge. Failed Condenser Blower. Failed Speed Controller.	Check discharge and suction pressure for Refrigerant leak. Check Blower wire connections. Check Blower Capacitor. Replace Condenser Blower. Check Speed Controller Sensor. Replace Speed Controller.
Unit not cooling. (Temperature difference between return and supply air is less than 10°F). Evaporator Blower, Condenser Blower and Compressor are running.	Condenser or Evaporator Coil clogged. Loss of Refrigerant. Ice on Evaporator Coil. Excessive condensate draining and loss of A/C sensible cooling performance.	Clean Coil. Locate and repair leak. Clean Evaporator Coil. Check discharge and suction pressure for Refrigerant leak. Check for any obstruction of Evaporator airflow. Check and seal all openings. Eliminate the frequency of door openings.
Unit overcooling. Evaporator Blower, Condenser Blower and Compressor are running.	Failed Thermostat. Failed Relay.	Check Thermostat wire connections. Replace Thermostat. Replace Relay.
Compressor cycling more than 10 cycles per hour.	Short circuiting of air between A/C discharge and inlet openings.	Provide baffle in the enclosure separating A/C Outlet and inlet.
Excess vibration.	Defective motor in Blower. Defective wheel in Blower. Bad Compressor.	Replace motor. Replace wheel. Replace Compressor.

X. Standard Warranty

KOOLTRONIC products are warranted to be free of defects in workmanship, materials and components. The following warranty periods apply from date of shipment:

- Air moving devices/components and hermetic system components: 1 year
- Spare parts, except filters: 90 days

The above warranty applies when the equipment is operated under the following conditions:

- Ambient temperature not in excess of 125°F (52°C) in normal atmosphere or as stated on product nameplate
- Voltage variation no greater than $\pm 10\%$ from nameplate rating
- Frequency variation no greater than $\pm 3\text{Hz}$ from nameplate rating
- Maximum cooling load no higher than air conditioner nameplate rating
- Waiting five minutes before restarting air conditioner after intentional or accidental shutoff
- Compliance to all other installation, maintenance and operating instructions, as supplied
- The purchaser assumes the responsibility of grounding the unit and installing it in accordance with local electrical and safety codes, as well as the National Electric Code (NEC) and OSHA

KOOLTRONIC cannot assume responsibility for mis-application of its products or the erroneous selection of an inappropriate product by a non-authorized KOOLTRONIC representative. Our applications engineers will gladly assist in the selection of the proper product, provided all required details of the application are furnished.

THIS WARRANTY CONSTITUTES THE ENTIRE WARRANTY WITH RESPECT TO THE PRODUCT AND IS IN LIEU OF ALL OTHERS, EXPRESSED OR IMPLIED, INCLUDING ANY WARRANTY OF MERCHANTABILITY AND WARRANTY OF FITNESS FOR A PARTICULAR PURPOSE AND IN NO EVENT IS KOOLTRONIC RESPONSIBLE FOR ANY CONSEQUENTIAL DAMAGES OF ANY NATURE WHATSOEVER.

RETURN AUTHORIZATION (RA) PROCEDURE

- All returns require a Return Authorization number whether the return is for warranty or non-warranty repair, rotation of stock, damage or any other reason. Returns without an RA number will be refused.
- Customer must call KOOLTRONIC After Sale Kare (ASK), Pennington, New Jersey (609 • 466 • 3400) to obtain an RA number, or email ask@kooltronic.com.
- The following information is required when an RA is requested:
 - Original customer Purchase Order number and date
 - Date product was received by customer
 - Number of parts to be returned
 - Product description, model and serial number
 - Reason for return
 - Action requested
 - Contact name, telephone, FAX numbers and e-mail address
- Pack unit in a suitable container for shipment, preferably the

KOOLTRONIC assumes no liability beyond the repair or replacement of its own product. This Warranty does not cover:

- Labor or reimbursement of labor for evaluation, removal, installation, repair, or cost of any warranted part, unless authorized in writing by KOOLTRONIC
- Use of equipment for other than its designed purpose or operating conditions
- Operation in harsh, oily, corrosive or other abnormal environmental conditions, without the proper filtration, sealing, protective coatings and/or weather protection
- Damage to hermetic system resulting from continuous operation with dirty or clogged air filters or improper or negligent maintenance
- Use of refrigerant other than designated
- Customer modification or abuse
- Shipping damage or other accident (Claims for shipping damage are the responsibility of the customer. Timely claims must be filed by the customer with the freight carrier)
- Cracked or broken hermetic tubing, brazed joints or other internal damage caused by shipping or mishandling
- Damage caused by shipping units attached to an enclosure
- Any and all conditions resulting from noncompliance with the preceding operating conditions
- Returned freight must be paid by customer
- **This standard warranty does not apply to custom products. Consult your KOOLTRONIC representative for limitations**

original packaging if available. All Air Conditioners must be returned in an upright position properly secured to a pallet. **Improper packaging may void warranty claim.** If an Air Conditioner is received laying down or shipped via UPS or similar small parcel service the warranty will be void.

- Mark carton prominently with KOOLTRONIC's Return Authorization Number.
- Enclose all pertinent documents.
- Freight charges on all products returned to KOOLTRONIC shall be paid by the customer. Unauthorized collect shipments will be refused.
- If a unit is repaired under Warranty, KOOLTRONIC will pay the freight charges both ways within the Continental USA at KOOLTRONIC's negotiated rates. Warranty repaired units will be returned to customer at KOOLTRONIC expense only within the Continental USA.
- All authorized returns are subject to a restocking fee.