

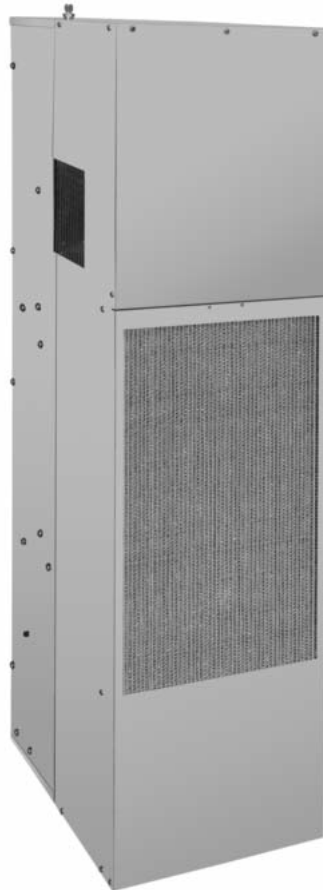

**HAZARDOUS LOCATION SERIES**  
**K3A4C12HL56LV**  
**480 VOLT 3-PHASE**  
**U.S. Pat. No. 9,157,670 B2**

**Keep This Manual  
With Air Conditioner**



*Find additional information on  
this model at [kooltronic.com](http://kooltronic.com) or  
use the Technical Documents  
QR code below.*

*Technical  
Documents*



# **AIR CONDITIONER OPERATOR'S MANUAL**

## **CAUTION**

**BEFORE INSTALLING AND  
USING THIS AIR CONDITIONER,  
IT IS IMPORTANT THAT THIS  
MANUAL BE READ AND  
UNDERSTOOD THOROUGHLY**



**KOOLTRONIC, INC.**  
**30 Pennington-Hopewell Road**  
**Pennington, NJ 08534**  
**609•466-3400**  
**FAX: 609•466-1114**  
**[www.kooltronic.com](http://www.kooltronic.com)**

# ***TABLE OF CONTENTS***

		Page
I.	Introduction	2
II.	Incoming Inspection	3
III.	Product Handling	3
IV.	Product Identification and Nameplate	4
V.	Warnings	5
VI.	Principles of Operation	6 - 9
VII.	Pre-Installation Testing	10
VIII.	Customer Enclosure Requirements	10 - 11
IX.	Specific Model Data	12 - 15
	Mounting	
	Drawings and Dimensions	
	Technical Data	
	Major Component Replacements	
	Standard Features	
X.	Maintenance	16 - 17
XI.	Trouble Shooting	17 - 18
XII.	Warranty	19

**NOTE:** Wiring Schematics are available on the specific model page of the Kooltronic website.

## ***I. Introduction***

Kooltronic Hazardous Location Air Conditioners (HL Series) are designed to provide a cool, dehumidified environment for your electronic components. Our "closed-loop" design also ensures that your components will not be exposed to hot, dirty operating conditions.

This Manual provides you with the necessary general information for properly installing and operating standard Kooltronic Air Conditioners. Mounting instructions and technical data are presented on pages 12 through 15.

## ***II. Incoming Inspection***

Kooltronic Air Conditioners are designed, built and packaged to withstand the shock and vibration normally associated with shipment by common carriers. Occasionally improper handling during shipping causes damage. Such handling could include unbanding of palletized shipments, failing to respect "**This Side Up**" arrows, rough handling, falling off conveyors, excessive vibration, crushing, etc. Therefore, a thorough inspection should be done upon receipt of all shipments. Any carton tears, dents, scratches, loose articles or evidence of oil are signs of damage and should be noted on the Freight Bill. Cartons should be opened promptly and the units inspected for CONCEALED DAMAGE. Kooltronic Air Conditioners must be delivered in the proper mounting position to assure that damage to the compressor has not occurred during shipping. Any Kooltronic Air Conditioner that is delivered removed from the banded pallet, lying down or double stacked should be refused.

An immediate claim **MUST** be filed with the freight carrier and an inspection requested. Retain all packing materials. Kooltronic cannot assume responsibility for Consignee's failure to file a timely freight claim.

## ***III. Product Handling:***

- 1) Do not attempt to operate your Kooltronic Hazardous Location Air Conditioner until you read and thoroughly understand this Manual. See section **VII PRE-INSTALLATION TESTING**.
- 2) Before operating the Kooltronic Hazardous Location Air Conditioner be certain that it is placed in its correct mounting position. **This Air Conditioner is designed to operate in a vertical position only.** This placement must be done a minimum of 5 minutes prior to operating in order to allow the compressor oil to drain to the compressor sump area.

### ***CAUTION***

**Kooltronic Air Conditioners must be operated in their proper mounting position. If attempts are made to operate a unit that is not in its designed mounting position, permanent compressor damage will occur. This action will void the warranty. To avoid compressor damage do not tip the unit more than 45° from its proper mounting position.**





- 3) Before operating this unit, all electrical wiring must be checked to assure the proper connection to the correct power source. Minimum circuit ampacity should be at least 125% of the amperage found on the nameplate for the corresponding voltage. Do not exceed the maximum fuse size found on the nameplate.
- 4) We do not recommend that Air Conditioners be shipped to their final destination attached to an enclosure. In the event that the Air Conditioner needs to be shipped attached to an enclosure it is strongly recommended that proper support be provided for the Air Conditioner. Excessive vibration can occur if Air Conditioners are not properly supported when shipped on enclosures, increasing the potential for internal damage and voiding the warranty.
- 5) **PROCEDURE FOR PROPER PACKING AND SHIPMENT OF KOOLTRONIC AIR CONDITIONERS:**
  - Keep Air Conditioner in proper upright position indicated by arrow markers.
  - Pack Air Conditioner in an appropriate carton (preferably original carton if possible), with adequate internal protective packaging, making sure carton is marked and is kept in correct upright position.
  - For local, controlled transportation, strap carton to a secure part of truck to prevent falling or sliding, minimize vibration, etc.
  - For common carrier shipment, band unit(s) securely to a pallet. Unpalletted shipment risks severe damage which voids the warranty.

## IV. Product Identification and Nameplate

Each Kooltronic Air Conditioner includes an identification nameplate. This nameplate provides:

- ① Model Number
- ② Serial Number
- ③ Cooling capacity
- ④ Heating capacity (Optional)
- ⑤ Electrical power characteristics
- ⑥ Type and amount of refrigerant required for recharging
- ⑦ Design Pressure
- ⑧ Maximum and minimum ambient operating temperatures
- ⑨ Manufacturing Order Number
- ⑩ Filter Part Number
- ⑪ Underwriters Laboratories Inc. Listed or Recognized Marks and NEMA ratings

We recommend you copy this information from your unit.

		Air Conditioner	
Model No. ①		Serial No. ②	
Cooling BTU/H: ③		Heating BTU/H: ④	
Rated Voltage: ⑤	Volts	Phase: ⑤	Hertz: ⑤
Evaporator Fan Motor: ⑤	Volts	Hp: ⑤	Amps: ⑤
Condenser Fan Motor: ⑤	Volts	Hp: ⑤	Amps: ⑤
Compressor: ⑤	Volts	L.R.A.: ⑤	R.L.A.: ⑤
Electric Heater: ⑤	Volts	Amps: ⑤	Watts: ⑤
Min. Circuit Ampacity: ⑤			
Max. Fuse Size / HACR Type Circuit Breaker: ⑤			
Refrigerant: ⑥	Oz. Factory Charge ⑥		
Design Pressure, High Side: ⑦	P.S.I.G.		
Design Pressure, Low Side: ⑦	P.S.I.G.		
Ambient Temperature: Min: ⑧	Max: ⑧		
Mfg. Order No.: ⑨			
Filter P/N: ⑩			
<p><b>SPECIAL PURPOSE AIR CONDITIONER</b>            NEMA/EEMAC/UL50 BY UNDERWRITERS LABORATORIES, INC.            TYPE 3R, 12 &amp; 4/4X INTERFACE TO THE ELECTRICAL ENCLOSURE ONLY            INTERNAL PRESSURIZED VOLUME CU. FT. - 10.8            AIR LEAKAGE @ 0.5 I.W.G. PRESSURE CFM - 0.4            UL RECOGNIZED AND CSA CERTIFIED FOR USE WITH CLASS I, DIVISION 1, GROUPS A, B, C AND D            HAZARDOUS LOCATIONS, TYPE X PURGE AND CLASS I, DIVISION 2, GROUPS A, B, C AND D,            TYPE Z PURGE ENCLOSURES WHEN INSTALLED ON AN APPROVED PRESSURIZED ENCLOSURE            AND CONNECTED TO PURGE/PRESSURIZATION CONTROL SYSTEM PER NFPA496            ALSO SUITABLE FOR CLASS I, ZONE 1, GROUPS IA, IIB PLUS HYDROGEN AND IIC            ALSO SUITABLE FOR CLASS I, ZONE 2, GROUPS IA, IIB PLUS HYDROGEN AND IIC            NEMA/EEMAC/UL50 BY UNDERWRITERS LABORATORIES, INC. TYPE 1            SPECIAL PURPOSE AIR CONDITIONER EQUIPMENT COMPARTMENT ONLY            OUTDOOR USE ALLOW 5 MINUTES BEFORE RESTARTING AFTER SHUTDOWN            UNAUTHORIZED SERVICE OR MODIFICATION VIOLATES WARRANTY            ALL MOTORS ARE THERMALLY PROTECTED SERVICE AIR FILTER REGULARLY            MANUFACTURED BY: KOOLTRONIC, INC. PENNINGTON, NJ</p>		   <b>LISTED 84H7            SPECIAL PURPOSE            AIR CONDITIONER</b> ⑪	

①②⑨ When ordering parts, specify the Model Number, Serial Number & MFG. Order Number.

⑤ Before operating, be sure that the power source matches these requirements.

⑥ Use of incorrect type or amount of refrigerant will adversely affect performance and may damage the unit.

⑧ Make sure that these parameters are met. Failure to do so may result in permanent damage to the unit.

## ***V. Warnings***

### ***WARNING - PRESSURIZED ENCLOSURE***

Kooltronic Air Conditioner K3A6C12HL56LV must be properly installed on a pressurized enclosure and connected to the pressurized enclosure Purge/Pressurized Control System before operating.

### ***WARNING - PRESSURIZED ENCLOSURE***

This Air Conditioner must not be opened unless the area atmosphere is known to be below the ignitable concentration of combustible materials or unless all devices within have been de-energized.

### ***WARNING - HIGH TEMPERATURE INTERNAL PARTS***

This Air Conditioner must not be opened unless the area atmosphere is known to be below the ignitable concentration of combustible materials or unless all devices within have been de-energized for at least thirty (30) minutes.

### ***WARNING FOR CLASS I ENCLOSURE***

After the Air Conditioner has been opened, power must not be restored until the Air Conditioner has been purged for the length of time required for the enclosure upon which the Air Conditioner is installed.

## VI. Principles of Operation

Kooltronic HL Series Air Conditioners are designed for Class I, Division 1 and Division 2 and Class I, Zone 1 and Zone 2 applications. They are used only when installed on pressurized customer enclosures and connected to a pressurized enclosure Purge/Pressurized Control System.

When Kooltronic HL Series Air Conditioners are installed on Class I customer enclosures, before operating they must be purged simultaneously with the pressurized customer enclosure according to the purge protocol for that pressurized enclosure.

The Purge/Pressurized Control System has to be selected by first taking into account the Kooltronic HL Series Air Conditioner volume and air leakage (these parameters are specified in the Technical Data on page 14), in addition to the volume and air leakage of the pressurized customer enclosure. The Kooltronic HL Series Air Conditioner and the pressurized customer enclosure must be connected to the Purge/Pressurized Control System by gas (air) lines in parallel.

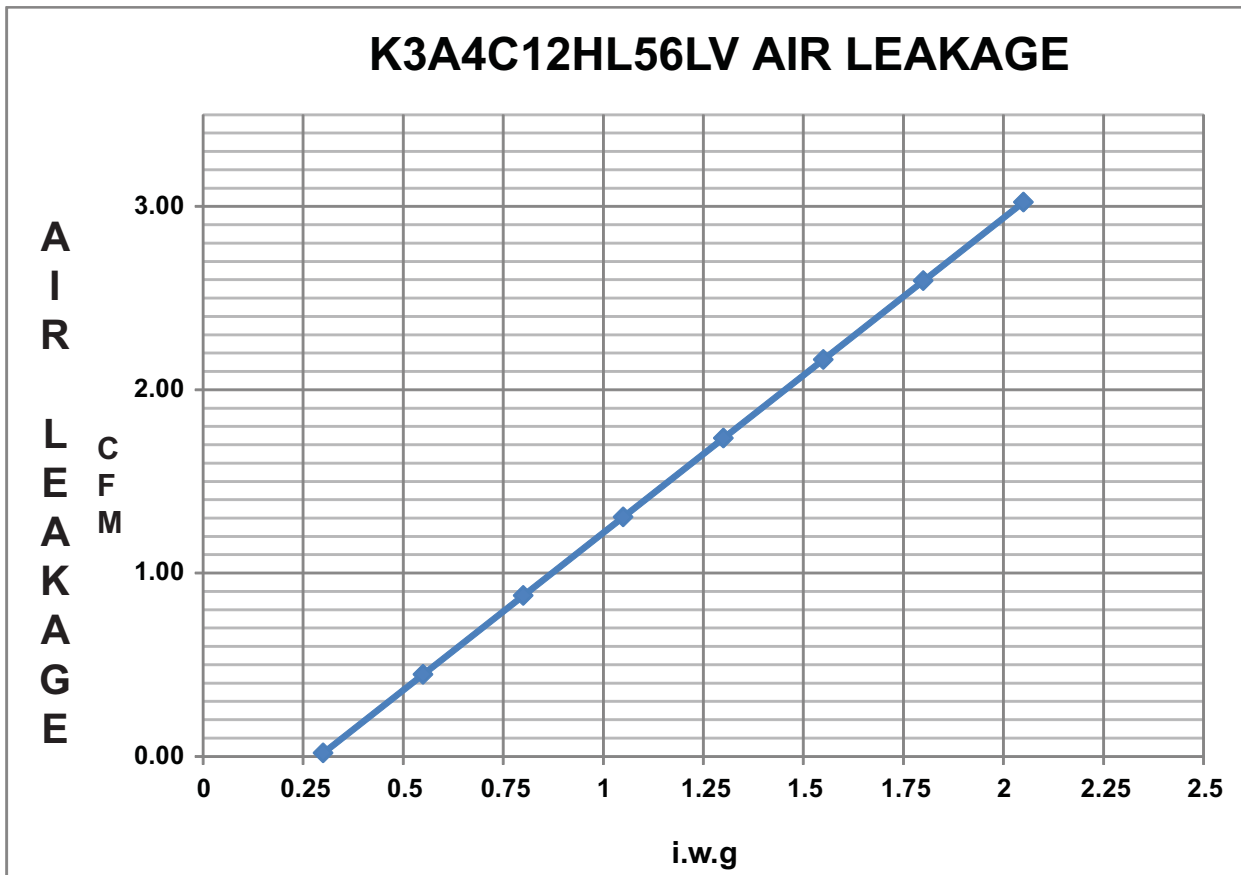

The Kooltronic HL Series Air Conditioner must be powered from the pressurized customer enclosure power supply, and the customer enclosure must be controlled by the Purge/Pressurized Control System.

All electrical and electronic components in the Kooltronic HL Series Air Conditioner are located in the pressurized evaporator enclosure.

Mechanical components, including the condenser blower housing and wheel, are made of aluminum, and are installed in the condenser compartment, exposed to ambient air. The condenser blower motor shaft extends from the evaporator compartment to the condenser compartment, and is sealed by a set of PTFE V-rings.

If condensate occurs in the Kooltronic HL Series Air Conditioner it will be removed through a drain line. In order to prevent pressurized gas (air) loss, the condensate drain system utilizes a floating type gate valve.

# Principles of Operation (con't)

Kooltronic Air Conditioners are required when the equipment operating temperature must be kept near or lower than the ambient room temperature, and/or the cabinet must be sealed from dust, fumes, oil, corrosives and other contaminants. These Air Conditioners utilize a "Closed-Loop Cooling System" to ensure optimum performance of the installed components.

Closed-Loop cooling seals the electronic enclosure from hostile elements in the environment. Two separate circulation systems are employed. The internal system cools and dehumidifies the air inside the cabinet, totally isolating the sensitive electronics and other components from the environment. The external system uses circulating ambient air or water to discharge the heat removed from the electronics. The heat is dissipated from the enclosure by means of the vapor compression refrigeration cycle. This takes place in a hermetically-sealed refrigeration system, utilizing either an air-cooled or water-cooled condenser heat exchanger. The warm air inside the enclosure is drawn through the evaporator coil where it is cooled, dehumidified and returned.

Any enclosure moisture accumulated on the evaporator coil is collected in the condensate tray and removed through the drain tube to the condensate evaporator. Condensate evaporates in the condensate evaporator and is released to the ambient air by the condenser impeller.

The heat removed through the evaporator coil is transferred by the compressed refrigerant to the condenser coil. Ambient air is then passed through the condenser coil, where it absorbs the heat and is then discharged to the environment.

This unit is equipped with a Low Temperature Thermostat to prevent the evaporator coil from freezing. In conditions of low ambient temperature and low enclosure load, the thermostat regulates the return air temperature from 75°F to 86°F. Temperature on the thermostat display is 5°F higher than the return temperature from the enclosure. The low temperature thermostat set point is 75°F. The set point can be adjusted. Consult with Kooltronic if the set point needs to be adjusted below 80°F.

The optional heater consists of a heater, a heat control thermostat and a heater limiter. The heater control thermostat is a bimetal disk with a fixed set point of 60°F. When the entering evaporator air temperature rises above 60°F the heater shuts off, and when the evaporator air temperature falls below 40°F the heater will engage. The heater limiter features a manual reset. This unit is equipped with a Temperature Alarm, which has normally-closed and normally open contacts, and a set point of 115°F. This unit is equipped with a high pressure switch. When abnormal conditions are detected, the switch shuts off the compressor. When the Kooltronic Air Conditioner is properly sized it should operate constantly and maintain 75°F to 115°F enclosure temperature, depending on the ambient temperatures.

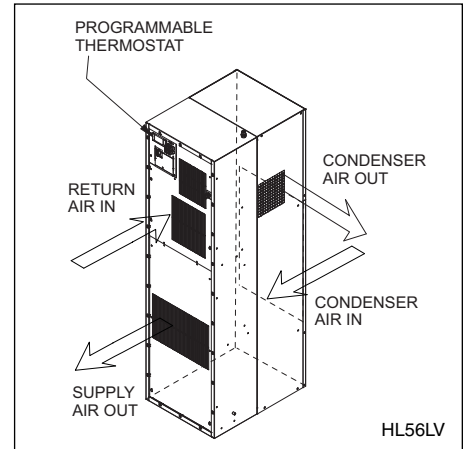

## CONTROL ACTION

The evaporator blower operates continuously. The compressor is cycled on and off by the action from the factory preset programmable thermostat. A pressure switch controls the on/off action of the condenser blower.

The regulation is performed according to the temperature measured by the thermostat probe with a positive differential from the set point: if the temperature increases and reaches set point plus differential the compressor is started and then turned off when the temperature reaches the set point value again.

In case of fault in the thermostat probe the start and stop of the compressor are timed through preset parameters.

The programmable thermostat is located as shown in the upper right ISO illustration. **WARNING:** the programmable device is preprogrammed and set at the factory. In the event changes are needed the following instructions can be used.

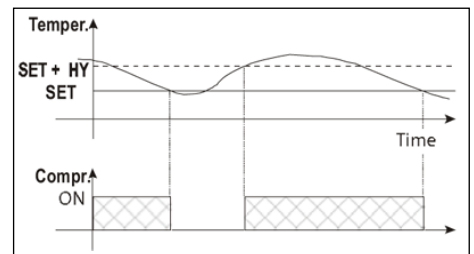

## FRONT PANEL COMMANDS



### KEY COMBINATIONS

- To lock and unlock the keyboard.
- SET** + To return to the room temperature display.
- SET** + To enter programming mode.

- SET** - To display target set point; in programming mode it selects a parameter or confirms an operation.
- (**UP**) - To see the max. stored temperature; in programming mode it browses the parameter codes or increases the displayed value.
- (**DOWN**) - To see the min. stored temperature; in programming mode it browses the parameter codes or decreases the displayed value.
- To switch the instrument off, if onF = OFF.
- Not enabled.
- (**DEF**) - To start a manual defrost.

## FRONT PANEL LED INDICATORS

LED Functions		
LED	MODE	FUNCTION
	ON	Compressor enabled
	Flashing	Anti-short cycle delay enabled
	ON	An alarm is occurring
	ON	Continuous cycle is running (not enabled)
	ON	Energy saving (not enabled)
'F'	ON	Measurement unit
'F'	Flashing	Programming phase

# ***Principles of Operation (con't)***

## **MAX AND MIN TEMPERATURE MEMORIZATION**

### **HOW TO SEE THE MIN TEMPERATURE:**

- 1) Press and release the down arrow ▼ key.
- 2) The “Lo” message will be displayed followed by the minimum temperature recorded.
- 3) Press the down arrow ▼ key again or wait 5 seconds to restore normal display.

### **HOW TO SEE THE MAX TEMPERATURE:**

- 1) Press and release the up ▲ arrow key.
- 2) The “Hi” message will be displayed followed by the maximum temperature recorded.
- 3) Press the up arrow ▲ key again or wait 5 seconds to restore normal display.

### **HOW TO RESET THE MAX AND MIN TEMPERATURE RECORDED:**

- 1) Press the SET key for more than 3 seconds while the max or min temperature is displayed. (rSt message will be displayed.)
- 2) To confirm the operation, the “rSt” message starts blinking and the normal temperature will be displayed.

## **MAIN FUNCTIONS**

### **HOW TO SEE THE SETPOINT:**

- 1) Press and immediately release the SET key. The display will show the set point value.
- 2) Press and immediately release the SET key, or wait 5 seconds to display the probe value again.

### **HOW TO CHANGE THE SETPOINT:**

NOTE: The standard set point is 80°.

- 1) Press the SET key for more than 2 seconds to change the set point value.
- 2) The value of the set point will be displayed and the °C or °F LED starts blinking.
- 3) To change the set value push the up ▲ or down arrow ▼ keys within 10 seconds.
- 4) To store the new set point value push the SET key again, or wait 10 seconds.

### **HOW TO CHANGE A PARAMETER VALUE:**

To change a parameter's value, operate as follows:

- 1) Enter the Programming mode by pressing the SET plus down arrow keys for 3 seconds (the °C or °F LED starts blinking).

- 2) Select the required parameter. Press the SET key to display its value.
- 3) Use up or down arrow keys to change its value.
- 4) Press SET to store the new value and move to the following parameter. To exit, press SET and the up arrow keys or wait 15 seconds without pressing a key.

NOTE: The set value is stored even when the procedure is exited by waiting for the time-out to expire.

### **HOW TO LOCK THE KEYBOARD:**

- 1) Press and hold the up and down arrow keys simultaneously for more than 3 seconds.
- 2) The POF message will be displayed, and the keyboard will be locked. At this point, it will only be possible to see the set point or the MAX or MIN temperature stored.
- 3) If a key is pressed more than 3 seconds, the POF message will be displayed.

### **HOW TO UNLOCK THE KEYBOARD:**

- 1) Press and hold the up and down arrow keys simultaneously for more than 3 seconds until the Pon message is displayed.

## **OPTIONAL MONITORING SYSTEM**

### **TTL SERIAL LINE - FOR OPTIONAL MONITORING SYSTEMS:**

The optional TTL serial line, available through the HOT KEY connector, allows through the use of the external TTL/RS485 converter, connection of this digital converter to a monitoring system that is ModBUS-RTU compatible (X-WEB500/3000/300). Connections are provided through an external 2-position terminal block.



# Principles of Operation (con't)

## RESETTING

If it becomes necessary to reset the unit, the factory settings are as follows.:

PARAMETER	DESCRIPTION	VALUE	UNIT	RANGE	
				MINIMUM	MAXIMUM
SEt	Set Point	75	°F	60	95
Hy	Differential	10	°F	1	45
dP4	Fourth probe display	0	--	--	--
dP3	Third probe display	0	--	--	--
dP2	Evaporator probe display	0	--	--	--
dP1	Room probe display	0	--	--	--
AFH	Differential for temperature alarm recovery	2	°F	1	45
ALL	Minimum temperature alarm	35	°F	-67	120
ALU	Maximum temperature alarm	120	°F	35	302
SHy	Differential for auxiliary relay	5	°F	1	45
SAA	Set point for auxiliary relay	115	°F	-67	302
ACH	Kind of action for auxiliary relay	CL	--	--	--
AC	Anti-short cycle delay	2	min	0	50
odS	Outputs delay at start up	0	min	0	255
P2P	Evaporator probe presence	n	--	--	--
ot	Thermostat probe calibration	0	°F	-21	21
US	Maximum set point	95	°F	75	302
LS	Minimum set point	60	°F	-67	75
Ptb	Map code	7	--	0	65535
rEL	Software release	0	--	--	--
rSE	Real set point	0	--	--	--
onF	on/off key enabling	ES	--	--	--
PbC	Kind of probe	ntc	--	--	--
Adr	Serial address	1	--	1	247
HES	Differential for energy saving	0	°F	-54	54
rrd	Regulation restart with door open alarm	y	--	--	--
odc	Compress status when open door	no	--	--	--
nPS	Number of activation of pressure switch	15	--	0	15
did	Digital input alarm delay	5	min	0	255
i1F	Digital input configuration	EAL	--	--	--
i1P	Digital input polarity	cL	--	--	--
dAO	Delay of temperature alarm at startup	00:00	h	--	--
ALd	Temperature alarm delay	0	min	0	255
ALc	Temperature alarms configuration	Ab	--	--	--
ArP	Probe selection for auxiliary alarm	P1	--	--	--
dLy	Display temperature alarm	00:00	min.	0	20
Lod	Probe displayed	P1	--	--	--
rES	Resolution	in	--	--	--
CF	Temperature measurement unit	F	--	--	--
CH	Kind of action: heating cooling	cL	--	--	--
COF	Compressor OFF time with faulty probe	4	min	0	255
COn	Compressor ON time with faulty probe	20	min	0	255
O4	Fourth probe calibration	0	°F	-21	21
P4P	Fourth probe presence	n	--	--	--
O3	Third probe calibration	0	°F	-21	21
P3P	Third probe presence	n	--	--	--
OE	Evaporator probe calibration	0	°F	-21	21

## VII. Pre-Installation Testing

Before mounting the air conditioner to the enclosure, test for proper operation to verify the shipping integrity of the system. Pre-installation testing must be done in a non-hazardous location.

### **CAUTION**

**The air conditioner must be standing in its proper mounting position for a minimum of five (5) minutes prior to testing. Failure to follow this procedure will cause permanent damage to the compressor. To avoid compressor damage do not tip the unit more than 45° from its proper mounting position.**

1. The unit must sit in an upright position at a minimum room temperature of 65°F to allow the system to warm-up. This is particularly important during winter months.
2. Refer to the nameplate for proper electrical voltage and current requirements. Connect the power cord to a properly grounded and fused electrical supply, leaving electrical power to the unit turned off.
3. Turn the electrical power on by turning the switch on the front panel to ON.
4. Observe the temperature on the digital display. The thermostat must be set a minimum of 5°F below this temperature for the compressor to operate (the factory setting is 75°F). To adjust the thermostat, push the SET button for two (2) seconds, then use the arrows to set the temperature. To store the new set point value push the SET key again, or wait ten (10) seconds.
5. Verify that the evaporator blower or fan is running.
6. After one (1) minute the condenser blower and compressor should start.
7. Verify that the condenser blower is running.
8. Operate the air conditioner for approximately ten (10) minutes. During this period no unusual noise or vibration should be evident. Both the evaporator and condenser fans or blowers should be delivering air through their respective discharge ports. The cool air discharged should be less than 70°F when the room temperature is between 70°F and 80°F.
9. Reset the thermostat to the factory setting (75°F).
10. Turn off the electrical power and disconnect the air conditioner from the power source.

**NOTE:** Before shipment all Kooltronic Air Conditioners are subjected to a performance test.

### **CAUTION**

**If the air conditioner is mounted to the cabinet door you must be sure that the door hinges will support the additional weight of the air conditioner. Also be certain that when the door is opened fully, the cabinet does not become unbalanced. The actual weight of the unit can be found in the Technical Data on page 14.**

## VIII. Customer Enclosure Requirements

1. The internal air conditioner pressurized volume is 10.8 cu. ft. as shown on the air conditioner nameplate. This volume must be added to the customer enclosure volume for proper selection of the Purge/Pressurized Control System.  
Air conditioner air leakage is 0.4 CFM at pressure 0.5 i.w.g. For other pressures see the table in "Principles of Operation on page 6. This air leakage should also be taken into account for proper selection of the Purge/Pressurized Control System.
2. The air conditioner must be connected to the main enclosure's (panel's) power, which must be de-energized upon loss of pressure by the enclosure Purge/Pressurized Control System.

## ***Customer Enclosure Requirements (con't)***

### ***Pressure Compensation***

#### ***CAUTION***

When an air conditioner is used on a sealed, pressurized enclosure the temperature inside the enclosure may change rapidly when the air conditioner starts and when the compressor cycles. These conditions may cause the enclosure pressure to decrease for a period of time below the required pressure. This can trip safety systems associated with the purge/pressurization control equipment. **It is recommended that the control equipment be selected and sized to compensate for this potential condition.** It is the user's responsibility to make careful adjustment to the pressure interlocks and flow adjustments to the purge system.

Should the purge/pressurization control equipment fail to compensate for the drop in pressure, a recommended safety measure is to provide an additional amount of pressurized air to the enclosure independent of the purge/pressurization control equipment (see drawing on page 12).

The Kooltronic air conditioner is equipped with an external terminal block marked "Pressure Compensation," which is connected to a relay inside the air conditioner. When the air conditioner compressor starts, the relay's contacts are closed.

Users of the air conditioner can utilize these contacts with their controls to add additional pressurized air to the enclosure. The contact closure may be used with their control system having a timer function and output signal. The output signal would energize a solenoid valve equipped with a fixed orifice or an adjustable needle valve within the enclosure. This would provide additional pressurized air for a selected period of time (typically two to three minutes). The relief valve utilized on the purge/pressurization control equipment must be capable of handling the capacity of the solenoid valve in a failure mode. The timer function allows pressurized air to be added during the time the temperature is ramping down within the enclosure, maintaining the proper pressure. Once temperature stability is achieved and the air conditioner is running constantly, the internal pressure will be controlled by the purge/pressurization control equipment. Subsequently, the solenoid valve is energized on each compressor start. The installation should be tested to determine enclosure pressures, safety interlock settings, system operation and the time interval that the solenoid air valve is open.

#### ***DISCLAIMER***

This information is provided as a general guide, and is not intended to be instructional. Kooltronic makes no claims, promises or guarantees about the accuracy, completeness or adequacy of this information. Any action taken based upon this information is strictly at your own risk.

Kooltronic accepts no liability for the content of this information, or for the consequences of any actions taken on the basis of the information provided.

## IX. Specific Model Data

### Mounting

#### CAUTION

**The air conditioner must be mounted in accordance with the mounting instructions in order to maintain the integrity of the panel enclosure.**

The Kooltronic HL Series Air Conditioners K3A4C12HL56LV have been engineered to be installed easily. Prior to mounting, refer to page 13 for the mounting plan showing dimensions and locations of mounting holes and cutouts. Prior to cutting or drilling, make sure that cutouts and mounting holes do not interfere with components inside the cabinet. To avoid damaging your air conditioner, please read the following information before installation:

1. It is recommended that a lift truck be used for installation.
2. These externally mounted air conditioners utilize a gasket to ensure a proper seal. This seal is necessary to maintain the integrity of the closed-loop system and the enclosure NEMA 4 or NEMA 4X Rating.
3. Secure the air conditioner to the enclosure using (24) 1/4-20 x 1-1/4 inch stainless steel bolts (supplied).
4. Using a clamp, attach plastic drain hose to the drain tubing near the bottom of the air conditioner.
5. The customer must connect the Purge/Pressurized System control line to the Swagelok fitting (B400-1-OR, 1/4 inch NPT). The customer has a choice of two connection fittings on the unit. One is for internal connection, and the other is for external connection (see illustration below). The unused fitting must be sealed with the provided cap.
6. The customer could use a Tee fitting, or any type fitting to connect the Purge/Pressurized System control line to the air conditioner.

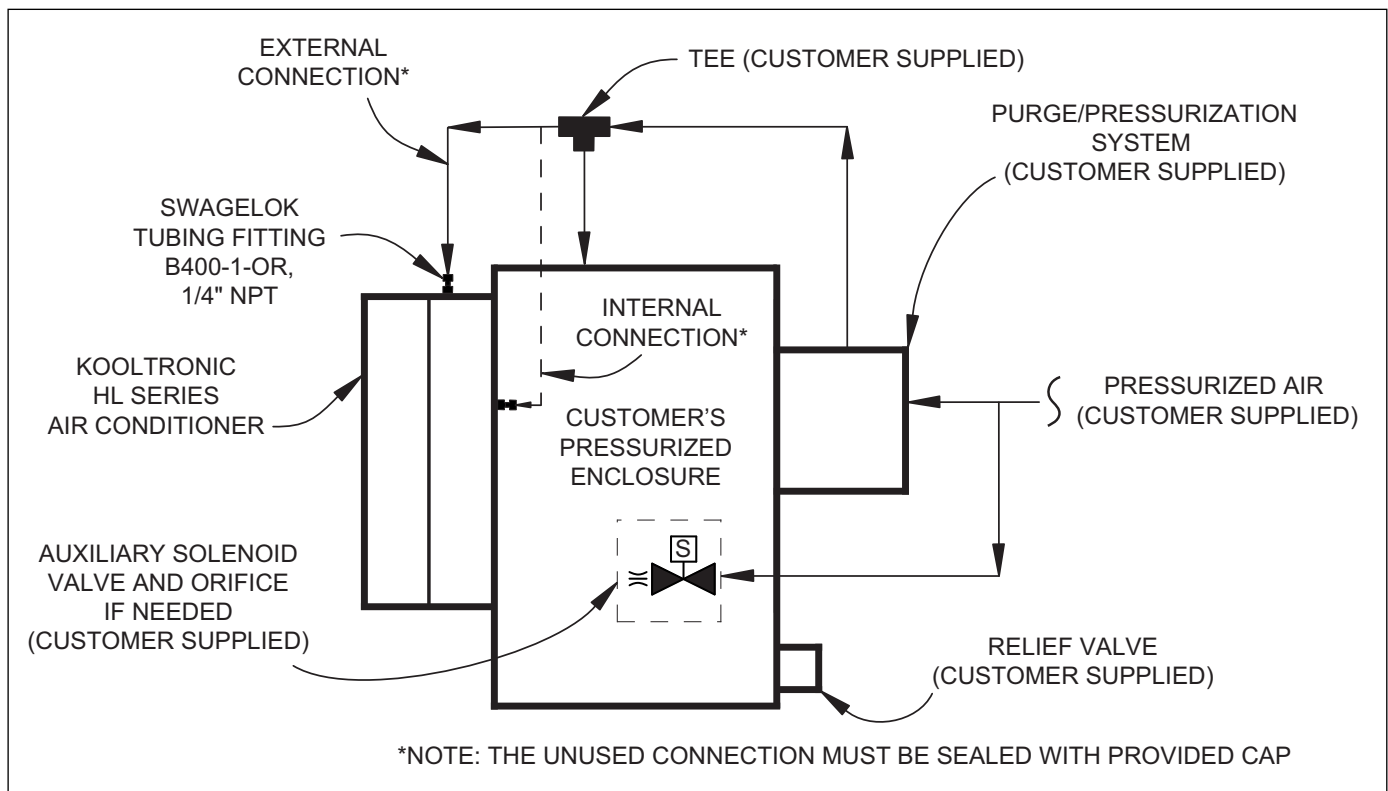

# Drawings and Dimensions

## MOUNTING PLAN

**K3A4C12HL56LV**

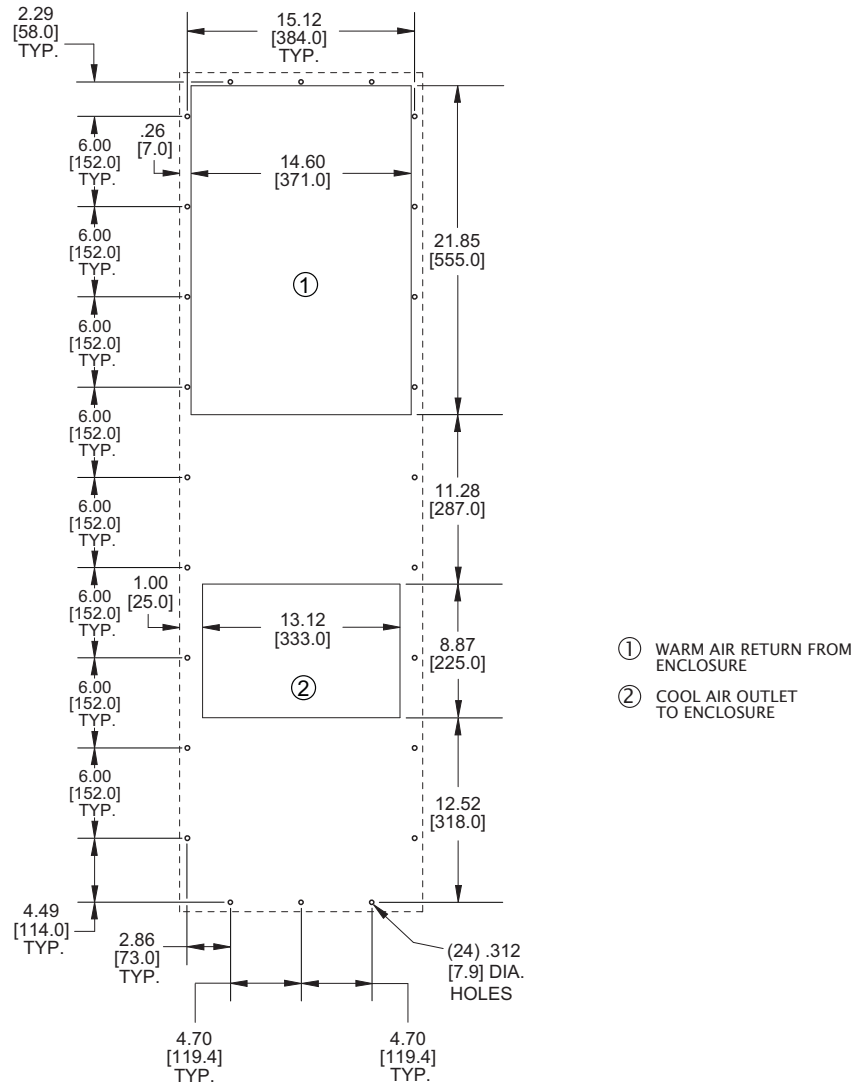

Dimensions, inches [metric], are for reference only and are subject to change.

# Drawings and Dimensions (con't)

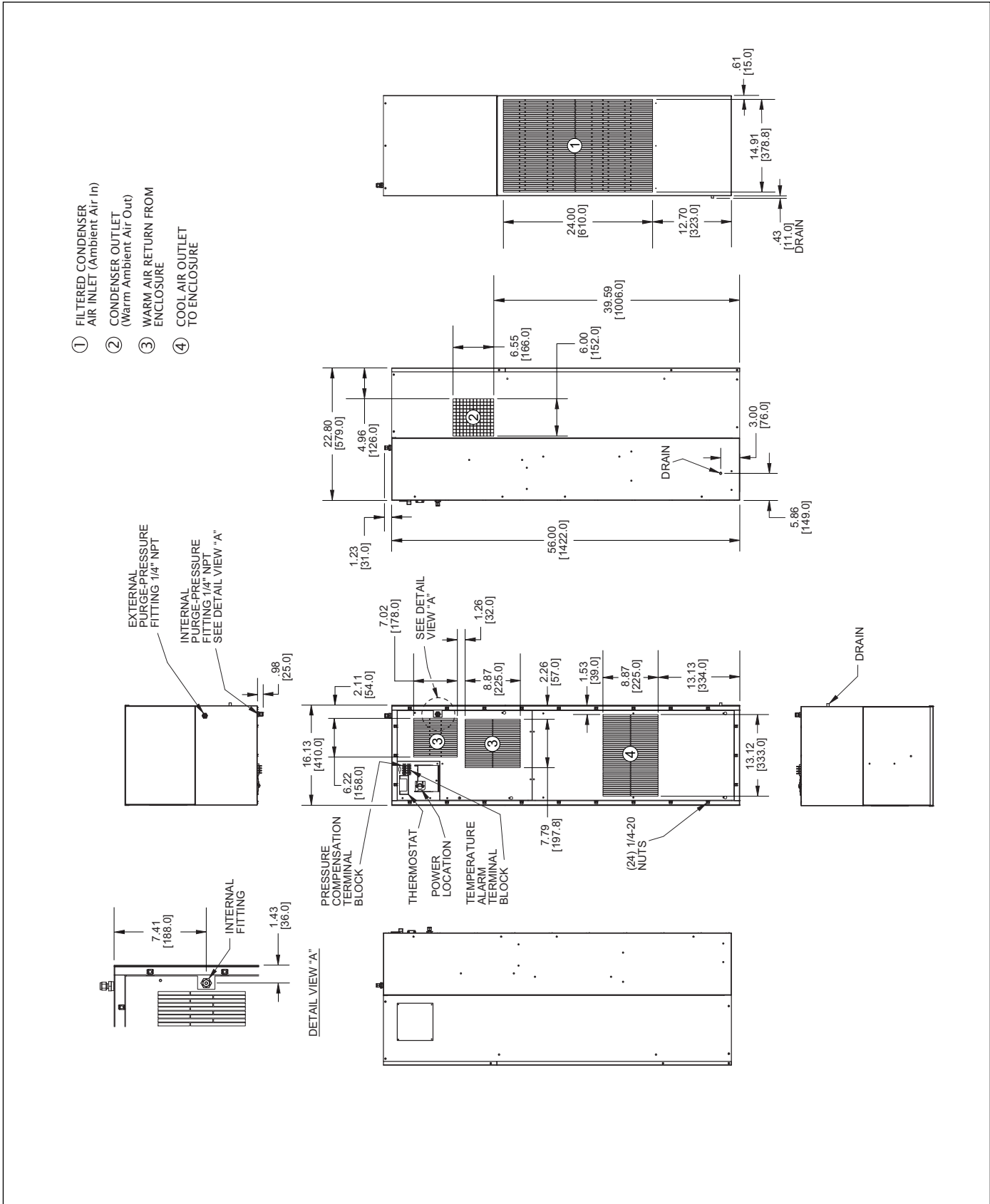

## Technical Data

Model	BTU/H Capacity	95/95 Rating BTU/H	Ambient Temp. °F Max./Min.	Volts	Hz	Running Amps 125°F/125°F	Pressurized Compartment Volume cu. ft.	Air Leakage @ 0.25 i.w.g. Pressure CFM	Approx. Weight lbs
K3A6C12HL56LV	12000	11000	125/-20	480	60	6	5.2	0.4	237
<b>K3A4C12HL56LV</b>	<b>12000</b>	<b>10940</b>	<b>125/-20</b>	<b>480</b>	<b>60</b>	<b>6</b>	<b>6.0</b>	<b>0.4</b>	<b>237</b>

Units in **BOLD** are current standard products. Other units are prior product offerings and shown for reference only.

## Major Component Replacements

Part	K3A6C12HL56LV Part Number	K3A4C12HL56LV Part Number
Compressor	0665-416	0665-143
Condenser Blower Motor	0261-307	0261-307
Condenser Blower Capacitor	0452-06	0452-06
Evaporator Impeller	0194-108	0194-108
Evaporator Impeller Capacitor	0452-03	0452-03
Condenser Coil	0666-74	0666-74
Evaporator Coil (2)	0666-73	0666-73
Temperature Controller	0750-141	0750-137
Temperature Controller Sensor	0750-136-01	0750-136-01
Condenser Blower Contactor	0694-93	0694-93
Compressor Contactor	0694-98	0694-98
Power Transformer	0932-40	0932-40
Fuse (1 Amp)	0916-29	0916-29
High Pressure Switch	0712-32	0712-41
Condenser Control Pressure Switch	N/A	0712-18
Filter	1524F	1524F

## Standard Features

All models UL Listed per UL 484, Special Purpose Air Conditioners

All models UL Recognized per NFPA 496: 2013, Purged and Pressurized Enclosures for Electrical Equipment Meets NEC Class I, Division 1, Groups A, B, C & D and Class I, Zone 1, Groups IIA, IIB plus hydrogen and IIC

Hazardous Locations when used with an approved Type X Purge System on the electrical enclosure

Meets NEC Class I, Division 2, Groups A, B, C & D and Class I, Zone 2, Groups IIA, IIB plus hydrogen and IIC

Hazardous Locations when used with an approved Type Z Purge System on the electrical enclosure

Temperature Classification is T-4, 275°F/135°C

Maintains NEMA Type 12, 3R & 4/4X Ratings per UL50, Cabinets and Boxes

Closed Loop Cooling

Compressor Short Cycling Protector

Filter

Interior and Exterior Purge Connections

Internal Corrosion Protection

Painted Condenser and Evaporator Coils

Pressure Compensation Terminal Block

Programmable Temperature Alarm

Programmable Thermostat

Shock and Vibration Resistance

Stainless Steel Shell

Zero ODP Refrigerant

## **X. Maintenance**

Kooltronic Air-Cooled Air Conditioners require routine cleaning of the condenser coil (as necessary) and the air filters to assure unimpeded airflow through the condenser heat exchanger. It is not possible to recommend specific condenser coil or filter cleaning intervals, since the level and the nature of airborne particulate matter differs widely with each installation. It is generally sufficient to clean the condenser coil and/or the aluminum mesh filter when the outer surfaces appear covered with a thin layer of dust, lint or other foreign matter. The condenser coil can be washed or blown out with air, depending on the foreign matter involved (see below - **Filter and condenser coil service**). The aluminum mesh filter can be washed with warm water. Appropriate disposable replacement filters are available from Kooltronic.

If routine condenser coil or filter service is neglected or delayed, the air conditioner will not perform at its design capacity. The first indication of an excessively clogged condenser coil or air filter is usually a gradual increase of temperature within the equipment cabinet. If operation is continued under these conditions, the compressor will be shut off by the thermal overload device. The compressor will restart when its external temperature drops below the protector threshold setting and the compressor will continue to cycle on and off. Continued operation under these conditions will cause damage, shorten compressor life and void the warranty.

### **A. Filter and condenser coil service**

The filter is installed in the unit. In order to clean the filter, remove the rear panel. After removal, the filter should be flushed under warm running water with clean side up. If the accumulated dirt is oily, washing in a detergent bath is recommended, followed by a warm water wash as above.

After filter removal, the exposed condenser coil must be cleaned by pressurized air or pressurized cleaning solution. Dirty liquid will be removed through the condenser coil drain pan.

### **B. Blowers**

The design life of the blowers used in all Kooltronic Air Conditioners is substantially in excess of 20,000 hours. All Kooltronic condenser and evaporator blowers are equipped with automatic-reset thermal overload protectors.

## **CAUTION**

**Before opening the air conditioner, disconnect all power.**

If field replacement of a blower motor is necessary, most blower assemblies, including the mounting plate, are removable. Each of the blower mounting plates is held to the air conditioner cabinet structure by screws and nuts. For installation of the replacement blower, electrical connections may be broken at the terminal block, or power leads may be cut and appropriately spliced together.

### **C. Compressor**

All Kooltronic compressors are approved by UL and CSA, and require no maintenance. They are hermetically sealed and charged at the factory, and equipped with automatic-reset thermal overload protectors.

If the compressor fails, it is strongly recommended that the air conditioner be returned to Kooltronic for service.

### **D. Refrigerant Loss**

Kooltronic Air Conditioners are subjected to a series of tests to detect refrigerant leaks, during and after manufacture. It is possible that shipping or other damage, or microscopic leaks over a long period, may result in the need for replenishment of refrigerant charge. **When it has been verified by a Certified EPA Technician that a refrigerant shortage does exist, the leak must be repaired. Then the unit may be evacuated and recharged in the field by a Certified EPA Technician only.**



## Maintenance (con't)

### CAUTION

Refer to the data on the unit nameplate which specifies the type of refrigerant and the amount of charge in ounces.

#### E. Relocation

If your Kooltronic HL Series Air Conditioner has to be moved to another location by truck, the following precautions should be taken:

- De-mount the air conditioner from the equipment, controller or enclosure (**see below: Removing Air Conditioner from Pressurized Enclosure.**)
- Conform to the applicable provisions of PROCEDURE FOR PROPER PACKING AND SHIPMENT OF KOOLTRONIC AIR CONDITIONERS in this manual under *Section III. "PRODUCT HANDLING"*.

#### F. Removing Air Conditioner from Pressurized Enclosure

Before removing a Kooltronic HL Series Air Conditioner from a pressurized enclosure, it must be confirmed that the temperature of the internal parts do not exceed Temperature Class (T Codes) for Class I, Division 1 and Class I, Zone 1 locations for the pressurized enclosure. If an internal heater is used in the air conditioner, internal part temperature will be at maximum. See table below for heater temperature after air conditioner is de-energized.

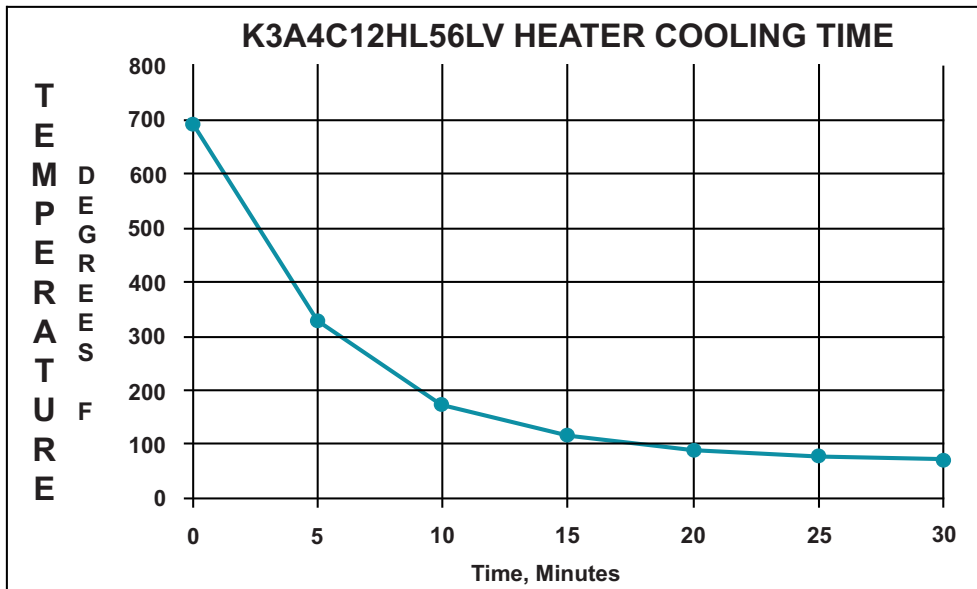

## XI. Trouble-Shooting

Each Kooltronic Air Conditioner is engineered for performance and built for reliability. They are designed to require only routine maintenance. If your air conditioner should require warranty service, please contact Kooltronic. If you require service out of warranty, we have compiled a trouble-shooting chart to assist your service personnel. If additional assistance is required, contact Kooltronic at (609) 466-3400.

Problem	Cause	Solution
Unit does not run.	No Power.	Check Power Source and electrical connection. Check unit ON-OFF switch (UL Listed units only). Check unit power cord connection to terminal block.

## Trouble-Shooting (con't)

Problem	Cause	Solution
<b>Compressor and Condenser Blower do not run when initially energized after 15 minutes.</b>	Return temperature is between Thermostat set point and differential (75°F to 86°F).	Normal Operation.
<b>Unit not cooling. (Temperature difference between return and supply air is less than 10°F).</b> Evaporator Blower is running. Compressor and Condenser Blower do not run. Return temperature is above set point plus differential (90°F).	Failed Thermostat or Relay.	Check Thermostat and Relay wire connections. Replace Thermostat or Relay.
	Low Line Voltage.	Check Nameplate Voltage against supply Voltage.
	Failed Compressor.	Check Compressor wire connections. Check Compressor overload. Check Compressor Capacitor. Replace Compressor.
<b>Unit not cooling. (Temperature difference between return and supply air is less than 10°F).</b> Compressor and Condenser Blower are running. Evaporator Blower does not run.	Failed Evaporator Blower.	Check Blower wire connections. Check blower capacitor. Replace Evaporator Blower.
<b>Unit not cooling. (Temperature difference between return and supply air is less than 10°F).</b> Compressor and Evaporator Blower are running. Condenser Blower does not run.	Low Refrigerant charge.	Check discharge and suction pressure for Refrigerant leak.
	Failed Condenser Blower.	Check Blower wire connections. Check Blower Capacitor. Replace Condenser Blower.
	Failed Speed Controller.	Check Speed Controller Sensor. Replace Speed Controller.
<b>Unit not cooling. (Temperature difference between return and supply air is less than 10°F).</b> Evaporator Blower, Condenser Blower and Compressor are running.	Condenser or Evaporator Coil clogged.	Clean Coil.
	Loss of Refrigerant.	Locate and repair leak.
	Ice on Evaporator Coil.	Clean Evaporator Coil. Check discharge and suction pressure for Refrigerant leak. Check for any obstruction of Evaporator airflow. Check and seal all openings.
	Excessive condensate draining and loss of A/C sensible cooling performance.	Eliminate the frequency of door openings.
<b>Unit overcooling.</b> Evaporator Blower, Condenser Blower and Compressor are running.	Failed Thermostat.	Check Thermostat wire connections. Replace Thermostat.
	Failed Relay.	Replace Relay.
<b>Compressor cycling more than 10 cycles per hour.</b>	Short circuiting of air between A/C discharge and inlet openings.	Provide baffle in the enclosure separating A/C Outlet and inlet.
<b>Excess vibration.</b>	Defective motor in Blower.	Replace motor.
	Defective wheel in Blower.	Replace wheel.
	Bad Compressor.	Replace Compressor.

## ***XII. Standard Warranty***

KOOLTRONIC products are warranted to be free of defects in workmanship, materials and components. The following warranty periods apply from date of shipment:

- Air moving devices/components and hermetic system components: 1 year
- Spare parts, except filters: 90 days

The above warranty applies when the equipment is operated under the following conditions:

- Ambient temperature not in excess of 125°F (52°C) in normal atmosphere or as stated on product nameplate
- Voltage variation no greater than  $\pm 10\%$  from nameplate rating
- Frequency variation no greater than  $\pm 3\text{Hz}$  from nameplate rating
- Maximum cooling load no higher than air conditioner nameplate rating
- Waiting five minutes before restarting air conditioner after intentional or accidental shutoff
- Compliance to all other installation, maintenance and operating instructions, as supplied
- The purchaser assumes the responsibility of grounding the unit and installing it in accordance with local electrical and safety codes, as well as the National Electric Code (NEC) and OSHA

**KOOLTRONIC cannot assume responsibility for mis-application of its products or the erroneous selection of an inappropriate product by a non-authorized KOOLTRONIC representative. Our applications engineers will gladly assist in the selection of the proper product, provided all required details of the application are furnished.**

**THIS WARRANTY CONSTITUTES THE ENTIRE WARRANTY WITH RESPECT TO THE PRODUCT AND IS IN LIEU OF ALL OTHERS, EXPRESSED OR IMPLIED, INCLUDING ANY WARRANTY OF MERCHANTABILITY AND WARRANTY OF FITNESS FOR A PARTICULAR PURPOSE AND IN NO EVENT IS KOOLTRONIC RESPONSIBLE FOR ANY CONSEQUENTIAL DAMAGES OF ANY NATURE WHATSOEVER.**

### ***RETURN AUTHORIZATION (RA) PROCEDURE***

- All returns require a Return Authorization number whether the return is for warranty or non-warranty repair, rotation of stock, damage or any other reason. Returns without an RA number will be refused.
- Customer must call KOOLTRONIC After Sale Kare (ASK), Pennington, New Jersey (609 • 466 • 3400) to obtain an RA number, or email ask@kooltronic.com.
- The following information is required when an RA is requested:
  - Original customer Purchase Order number and date
  - Date product was received by customer
  - Number of parts to be returned
  - Product description, model and serial number
  - Reason for return
  - Action requested
  - Contact name, telephone, FAX numbers and e-mail address
- Pack unit in a suitable container for shipment, preferably the

KOOLTRONIC assumes no liability beyond the repair or replacement of its own product. This Warranty does not cover:

- Labor or reimbursement of labor for evaluation, removal, installation, repair, or cost of any warranted part, unless authorized in writing by KOOLTRONIC
- Use of equipment for other than its designed purpose or operating conditions
- Operation in harsh, oily, corrosive or other abnormal environmental conditions, without the proper filtration, sealing, protective coatings and/or weather protection
- Damage to hermetic system resulting from continuous operation with dirty or clogged air filters or improper or negligent maintenance
- Use of refrigerant other than designated
- Customer modification or abuse
- Shipping damage or other accident (Claims for shipping damage are the responsibility of the customer. Timely claims must be filed by the customer with the freight carrier)
- Cracked or broken hermetic tubing, brazed joints or other internal damage caused by shipping or mishandling
- Damage caused by shipping units attached to an enclosure
- Any and all conditions resulting from noncompliance with the preceding operating conditions
- Returned freight must be paid by customer
- **This standard warranty does not apply to custom products. Consult your KOOLTRONIC representative for limitations**

original packaging if available. All Air Conditioners must be returned in an upright position properly secured to a pallet. **Improper packaging may void warranty claim.** If an Air Conditioner is received laying down or shipped via UPS or similar small parcel service the warranty will be void.

- Mark carton prominently with KOOLTRONIC's Return Authorization Number.
- Enclose all pertinent documents.
- Freight charges on all products returned to KOOLTRONIC shall be paid by the customer. Unauthorized collect shipments will be refused.
- If a unit is repaired under Warranty, KOOLTRONIC will pay the freight charges both ways within the Continental USA at KOOLTRONIC's negotiated rates. Warranty repaired units will be returned to customer at KOOLTRONIC expense only within the Continental USA.
- All authorized returns are subject to a restocking fee.