

These units are discontinued, and this information is presented for reference purposes only.
 Recommended replacement: See *Guardian/GuardianX* or *SlimKool* Series or current *TrimLine* Series.

TECHNICAL DATA

Model	BTU/H Capacity	95/95 Rating BTU/H	Ambient Temp. °F Max./Min.	Volts	Hz	* Cooling Amps	Heating Amps	Approx. Weight (lbs)
K2A3C30EP62R	30000	26000	115/0	230	60	24.0	15.3	304

STANDARD FEATURES

- EMI/RFI Suppressor
- Condenser Fan Speed Controller
- Crankcase Compressor Heater
- Heavy-duty Steel Enclosure
- Low Temperature Control Thermostat
- NEMA 3R, 12 & 1 Ratings Maintained (UL50)
- Textured Baked Powder Finish
- UL/CUL Recognized

ACCESSORIES AND OPTIONS

- Enclosure Heater
- Internal Corrosion Protection
- Lead-Lag Controller
- Remote Thermostat Relay
- Special paint finishes
- Temperature Alarm

DISCONTINUED



NEMA
 TYPE 3R, 12 & 1
 MAINTAINED 

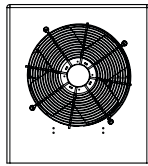
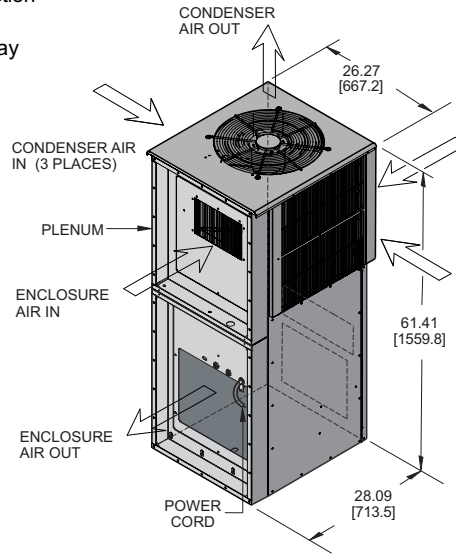

TOP

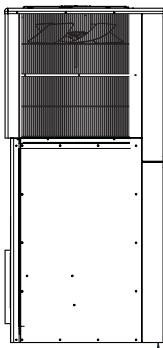

LEFT SIDE

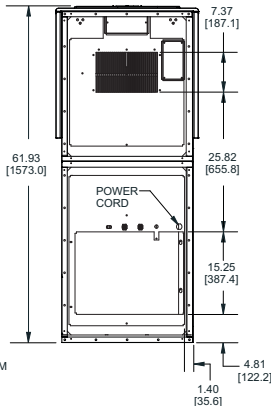

FRONT

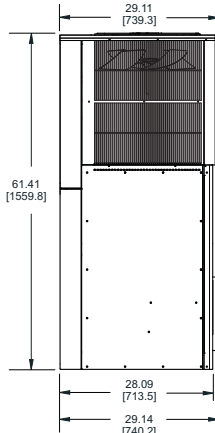

RIGHT SIDE

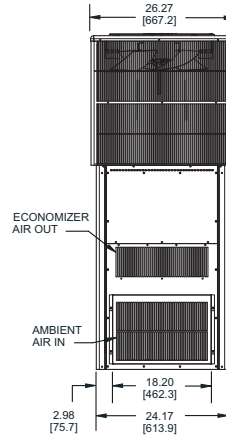

BACK

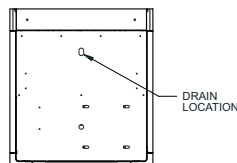
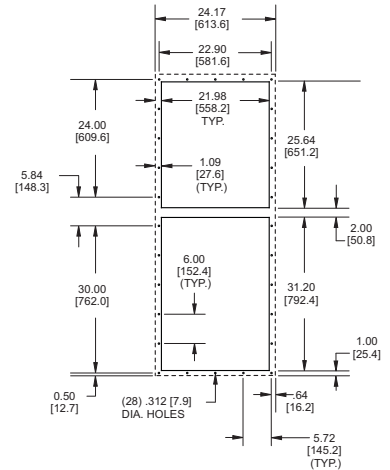

- ① CONDENSER AIR INLET (Ambient Air In) (3 sides)
- ② CONDENSER OUTLET (Warm Ambient Air Out)
- ③ WARM AIR RETURN FROM ENCLOSURE
- ④ COOL AIR OUTLET TO ENCLOSURE

Dimensions, inches [mm], are for reference only and subject to change.

* Rating shown is for operation at maximum ambient temperature.

ep62d.qxd (1/26/21) (CDR: 20293)