

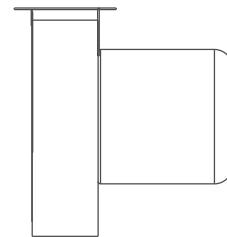

THIS DOCUMENT IS THE PROPERTY OF KOOLTRONIC, INC. AND CONTAINS PROPRIETARY AND CONFIDENTIAL INFORMATION WHICH MUST NOT BE DUPLICATED, USED OR DISCLOSED TO OTHERS, EXCEPT AS EXPRESSLY AUTHORIZED IN WRITING BY KOOLTRONIC, INC.

REVISIONS				
SYM	NOTICE	DESCRIPTION	DATE	APPROVED
-		NEW DRAWING RELEASE	11/25/19	SDS/

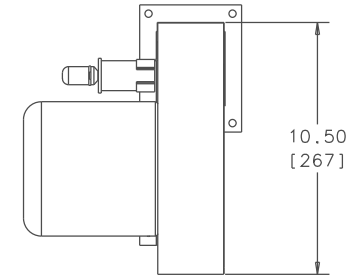
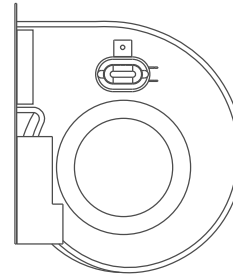
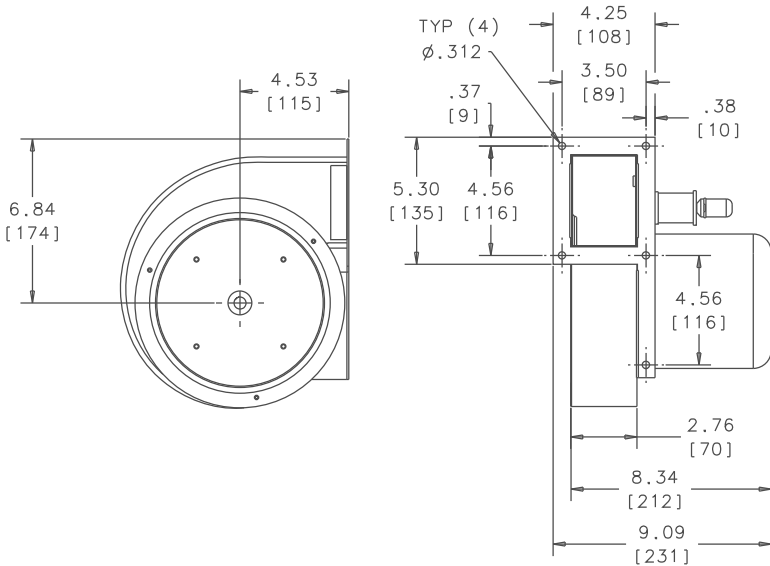
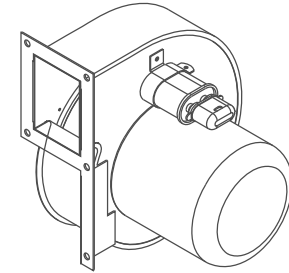
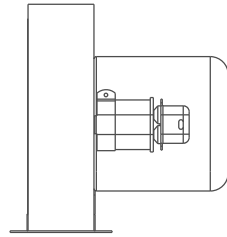

UNLESS OTHERWISE SPECIFIED TOLERANCES NON-ACCUMULATIVE				DATE			
TOL. ON	INCHES	MM	CHECKED	DATE			
.XX	± .02	±	Steve Schmierer	11/25/19	<b>GENERAL ARRANGEMENT KBB65</b>		
.XXX	± .010	±	ENG.				
ANGULAR	± 1/2 °		MFG. ENG.				
MATERIAL			APPROVED	CODE IDENT. NO.	SIZE	DWG. NO.	REV
UNIT KBB65				06223	C	KBB65	-
				SCALE .25=1	CAD. REF.	SHEET 1	OF 1