

THIS DOCUMENT IS THE PROPERTY OF KOOLTRONIC, INC. AND CONTAINS PROPRIETARY AND CONFIDENTIAL INFORMATION WHICH MUST NOT BE DUPLICATED, USED OR DISCLOSED TO OTHERS, EXCEPT AS EXPRESSLY AUTHORIZED IN WRITING BY KOOLTRONIC, INC.

REVISIONS				
SYM	NOTICE	DESCRIPTION	DATE	APPROVED
-	EC 21/116	NEW DRAWING RELEASE	11/23/21	JS/SDS

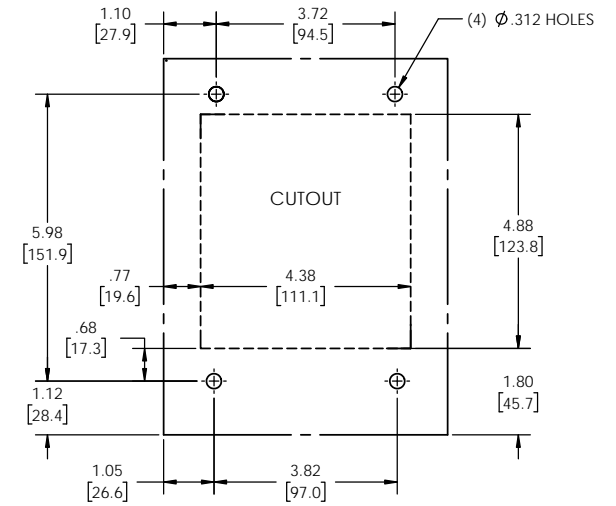

MOUNTING PLAN

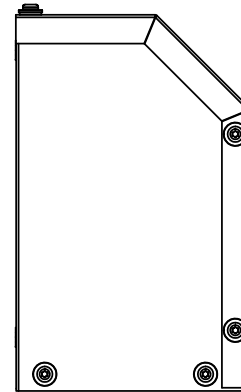
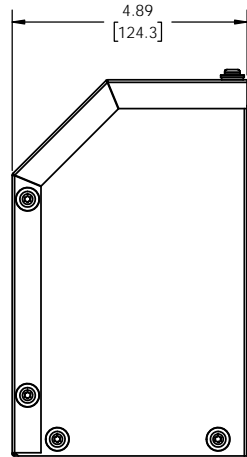
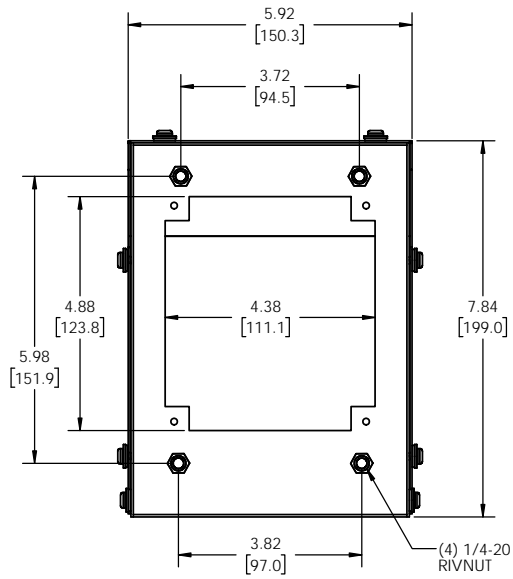
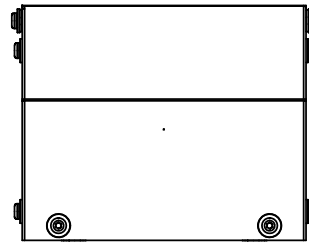
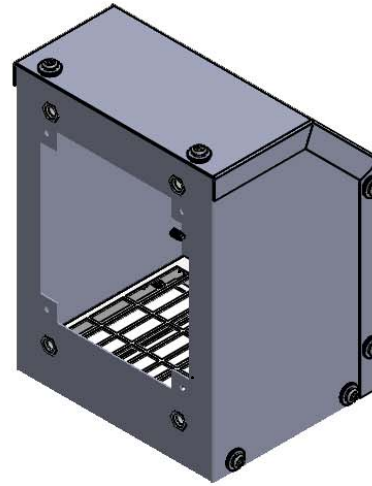
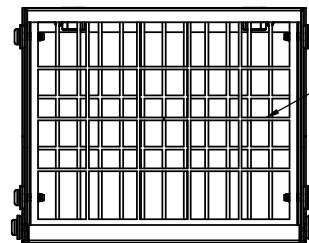

FILTER

UNLESS OTHERWISE SPECIFIED TOLERANCES NON-ACCUMULATIVE			DRAWN	DATE
TOL. ON	INCHES	MM	JERRY STEDNICK	11/23/21
.XX	± .02	±	CHECKED	
.XXX	± .010	±	Steve Schmierer	11/23/21
ANGULAR		± 1/2°	ENG.	
			Ron Kaufman	11/23/21
			MFG. ENG.	
MATERIAL			APPROVED	
UNIT	KNPA36FL (V)		BKKreeley	11/29/21



PENNINGTON, NJ USA

TITLE: GENERAL ARRANGEMENT KNPA36FL & V

CODE IDENT. NO.	SIZE	DWG. NO.	REV
06223	C	GA3270AA	-
SCALE 1:2	CAD. REF.	SHEET	1 OF 1