

THIS DOCUMENT IS THE PROPERTY OF KOOLTRONIC, INC. AND CONTAINS PROPRIETARY AND CONFIDENTIAL INFORMATION WHICH MUST NOT BE DUPLICATED, USED OR DISCLOSED TO OTHERS, EXCEPT AS EXPRESSLY AUTHORIZED IN WRITING BY KOOLTRONIC, INC.

REVISIONS		DATE	APPROVED
SYM	NOTICE	DESCRIPTION	
-	ER 11/083	NEW DRAWING RELEASE	4/13/12 JS

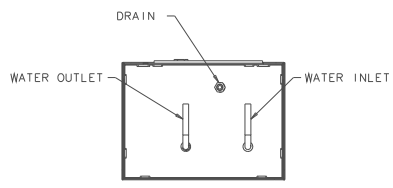

ALL DIMENSIONS ARE IN INCHES. DIMENSIONS DESIGNATED M ARE IN MILLIMETERS. UNLESS OTHERWISE SPECIFIED TOLERANCES NON-DECIMALATIVE.		DRAWN: JERRY STEDNICK CHECKED: Steve Schmierer ENG: Ron Kaufman MFG. ENG.		DATE: 1/24/12 4/18/12 7/12/12
TOL. ON	INCHES	M	TITLE	
.xx	: .02	:	GENERAL ARRANGEMENT	
.xxx	: .010	:	CODE IDENT. NO. SIZE DWG. NO. REV 06223 D GA710024A -	
MATERIAL			SCALE: 25=1	CAD. REF.
UNIT	K_NHE24	APPROVED: Joe M/Bruce K	8/17/12	SHEET 1 OF 1

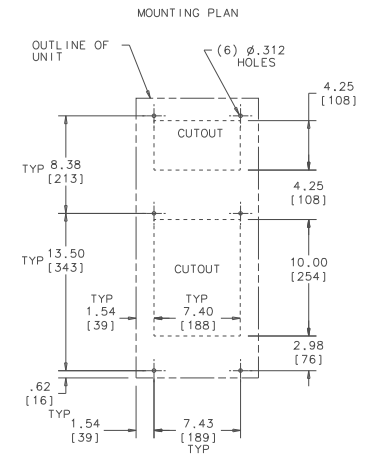
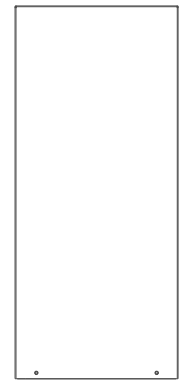
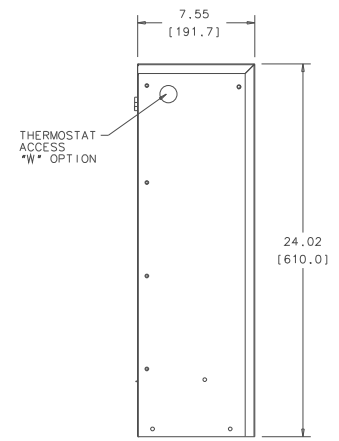
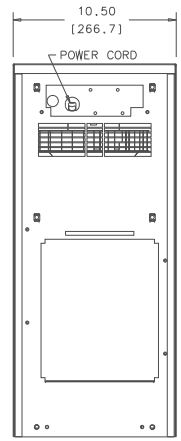
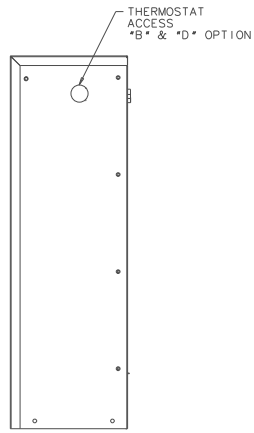
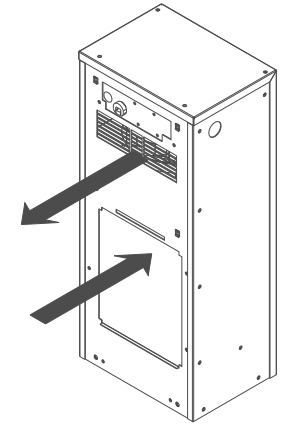