

THIS DOCUMENT IS THE PROPERTY OF KOOLTRONIC, INC. AND CONTAINS PROPRIETARY AND CONFIDENTIAL INFORMATION WHICH MUST NOT BE DUPLICATED, USED OR DISCLOSED TO OTHERS, EXCEPT AS EXPRESSLY AUTHORIZED IN WRITING BY KOOLTRONIC, INC.

SYM		NOTICE		REVISIONS		DATE	APPROVED
-					PRELIMINARY DRAWING	9/17/14	DW-

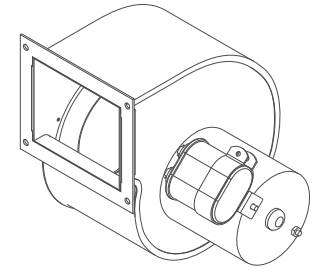

ISO VIEW SCALE: .75"=1"

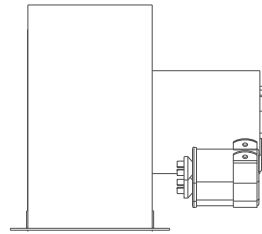
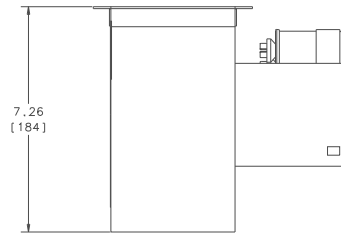
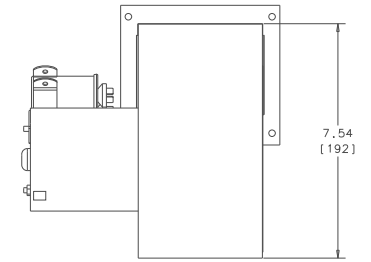
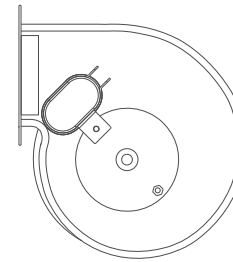
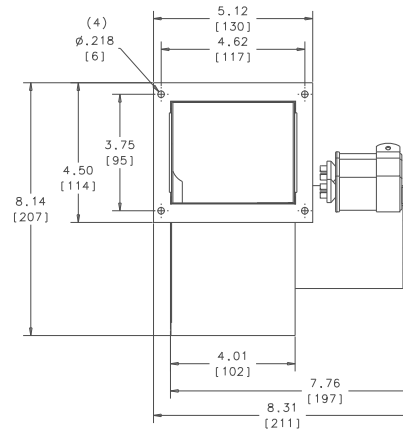
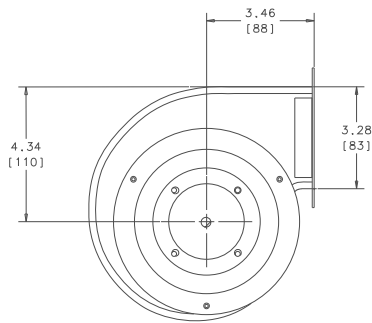

ALL DIMENSIONS ARE IN INCHES. DIMENSIONS DESIGNATED MM ARE IN MILLIMETERS.				UNLESS OTHERWISE SPECIFIED TOLERANCES NON-DECIMALIVE.		DATE	APPROVED
TOL. ON	INCHES	MM	CHECKED	DATE	APPROVED	DRAWN: D. WALDRON 9/17/14	
.XX	± .02	±	ENG.			TITLE: KBB43	
.XXX	± .010	±	MFG. ENG.			Kooltronic, Inc. POMONA, NJ USA	
ANGULAR	± 1/2	°				CODE IDENT. NO.   SIZE   DWG. NO.   REV	
MATERIAL						06223   D   KBB43   -	
UNIT	KBB43		APPROVED			SCALE: .5=1   CAD. REF.   SHEET 1 OF 1	