

These units are discontinued, and this information is presented for informational purposes only.  
Recommended replacement: See *Guardian/GuardianX* or *SlimKool Series* or current *TrimLine Series*.

**NEMA  
TYPE 12 & 3R  
MAINTAINED**

**UL  
US**



DISCONTINUED

## TECHNICAL DATA

Model	Normally in Stock	BTU/H Capacity	95/95 Rating BTU/H	Ambient Temp. °F Max./Min.	Volts	Hz	Running Amps*	Approx. Weight (lbs.)
KA3C8RP47R	Yes	8000	6600	125/0	115/100	60/50	12.2/12.7	150
K2A3C8RP47R	Yes	8000	6600	125/0	230/200	60/50	5.7/5.9	150
KA3C12RP47R	Yes	12000	8500	125/0	115/100	60/50	19.8/19.1	150
K2A3C12RP47R	Yes	12000	8500	125/0	230/200	60/50	9.1/9.0	150

## PERFORMANCE

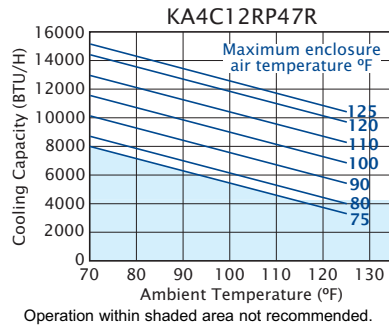
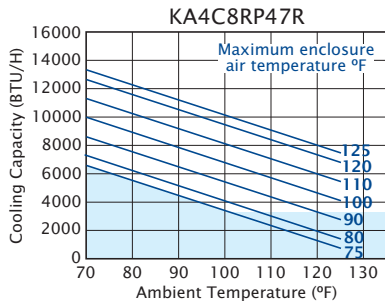

## STANDARD FEATURES

- Built-in Condensate Evaporator
- Low ODP Refrigerant
- Rotary Compressor
- Digital Temperature Display
- EMI/RFI Suppressor
- Filter
- Head Pressure Control Switch
- Low Temperature Control Thermostat
- M/TAB Mounting System
- NEMA 12 & 3R Ratings Maintained (UL50)
- UL/CUL Recognized

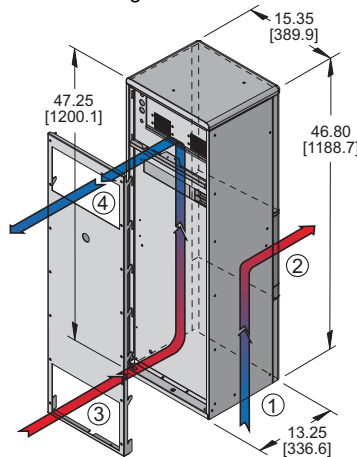

## ACCESSORIES AND OPTIONS

- Cooling Effect Detector
- Enclosure Heater
- Filter Recoating Adhesive
- Internal Corrosion Protection
- Painted Metal Grille Remote Thermostat Relay
- Replacement Filters
- Short Cycle Protector
- Special controls or indicators
- Special motors, line cords, or connectors
- Special paint finishes
- Stainless or Aluminum Shell

- ① FILTERED CONDENSER AIR INLET (Ambient Air In)
- ② CONDENSER OUTLET (Warm Ambient Air Out)
- ③ WARM AIR RETURN FROM ENCLOSURE
- ④ COOL AIR OUTLET TO ENCLOSURE

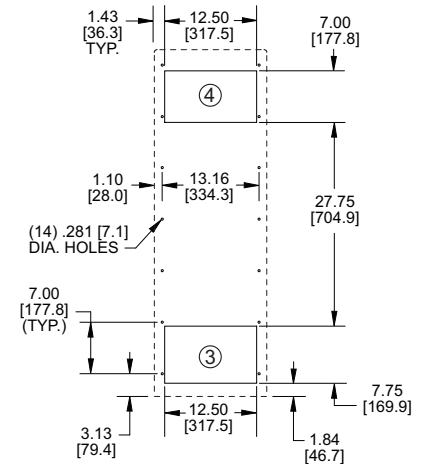
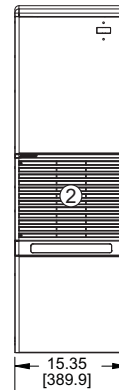
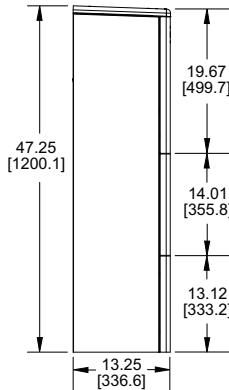
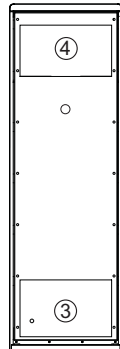

MOUNTING PLAN



Scan with your smart phone  
to visit [kooltronic.com](http://kooltronic.com)

UNIT MUST BE 4" [100mm]  
MINIMUM ABOVE FLOOR  
FOR FILTER ACCESS

Dimensions, inches [mm], are for reference only and subject to change.

▼ UL/CUL Listed models are available at added cost.

\*Rating shown is for operation at maximum ambient temperature.

rp47d.qxd (12/21) (CDR: 20369)

## DESCRIPTION

At last - air conditioners designed specifically for cooling electronic enclosures that can be used for both indoor and outdoor applications right out of the box! No more bulky unattractive weather hoods... No more worries over what options to specify for outdoor applications.

Expertly designed and crafted, the **ADVANTAGE Series** boasts a stylish appearance with rounded edges, no visible hardware and a textured baked powder finish to blend easily with contemporary enclosure designs.

Servicability has been made easier by incorporating a "knock-down" sheetmetal design which provides quick access to internal components.

Standard features include heavy duty galvanized steel construction with baked-on powder paint, environmentally friendly refrigerants, built-in condensate evaporator, thermostatic low temperature control and EMI/RFI Suppressor. These air conditioners are available in capacities from 2,000 to 22,000 BTU/H in seven heights, all utilizing the exclusive KOOLTRONIC M/TAB integral mounting system.

**KOOLTRONIC also designs and manufactures a variety of Air Conditioners to meet *unique* specifications. We invite your inquiries about our modification and custom-design capabilities.**

## STANDARD FEATURES

**CLOSED-LOOP COOLING:** The enclosure interior airflow system is isolated from the ambient airflow system. Ambient air can not invade the cool, dehumidified sensitive component compartment.

**BALL-BEARING MOTORS:** All fan motors are UL/CSA Recognized and include automatic-reset thermal overload protection and double-sealed or double-shielded precision ball bearings. Special permanent lubricants in the tube axial fans perform over a broad temperature range: -20°F [-28.9°C] to 250°F [121.1°C].

**RUGGED CONSTRUCTION:** Precision-engineered heavy gauge steel construction of all shells and blowers insures Air Conditioners will stand up under tough applications.

**TEXTURED BAKED POWDER FINISH:** Durable, baked-on textured beige powder finish is standard. Other finishes are available.

**POWER:** Available in 115 VAC, 60 Hz or 50/60 switchable and 230 VAC, 50 Hz or 60 Hz.

**REFRIGERANT:** Low Ozone Depleting Potential (ODP) R22 Refrigerant is used in all **Advantage RP47 Series** Air Conditioners and are being converted to CFC-free R134a Refrigerant as compressors become available. Consult KOOLTRONIC for status at time of requirement.

**FILTERS:** Multi-layer grid of sturdy, corrugated aluminum in an aluminum frame. May be reused after washing off accumulations and spraying with A-16 Recoating Adhesive.

**CONDENSATE EVAPORATOR:** Built-in Condensate Evaporator eliminates need for draining condensate under normal operating conditions. May not be adequate in extremely high humidity with open or leaky enclosure. Overflow condensate drain fitting and hose are included.

**LOW AMBIENT KIT:** Maintains sufficient operating pressures when ambient temperatures drop below 50°F [10°C]. Includes a compressor heater and pressure actuated condenser blower cycling control.

**LOW TEMPERATURE CONTROL:** Thermostatic Low Temperature Control prevents over-cooling and provides energy-efficient operation.

**EMI/RFI SUPPRESSOR:** EMI/RFI Suppressor minimizes transient line spikes during on/off cycling.

**CRANKCASE COMPRESSOR HEATER:** 120V or 240V heater attached to the compressor crankcase to maintain appropriate temperatures during cold operating conditions.

**HEAD PRESSURE CONTROL SWITCH:** A control device to minimize compressor cycling and prevent evaporator coil icing.

**POWER CORD:** All models have six foot [1.8m] SJT-type 3-wire power cords.

**INSULATION:** All cold components, lines and the evaporator compartment are insulated with high-performance insulation for maximum efficiency.

**GASKETING:** All units are fully gasketed for tight, leakproof installation, in compliance with the NEMA 3R Enclosure Rating.

**QUALITY ASSURANCE:** Refrigeration system components are kept sealed until charged with refrigerant; all brazed joints are thoroughly leak-tested; each unit is functionally tested before shipment.

**INSTALLATION:** Detailed Installation and Operator's Manual, with drawings, mounting plan and spare parts list is included with each unit.

**UL/CUL RECOGNIZED:** All **Advantage RP47** models are *UL/CUL Recognized*. All **Recognized** models are available as **Listed** at added cost.

## ACCESSORIES AND OPTIONS\*\*

### FACTORY-INSTALLED OPTIONS:

**COOLING EFFECT DETECTOR:** A thermostat is mounted inside the cabinet and attached to a sensor in the warm air return. When the air temperature increases to the set point, a signal is sent to a terminal block. User-installed wiring from the terminal block to local and/or remote warning devices (*light, bell, siren, etc.*) can be for normally open or closed operation.

Append letter "B" to Part No.

**ENCLOSURE HEATER:** 120V or 240V fin strip heater, installed singly or ganged, used to maintain desired internal enclosure temperature, under cold operating conditions.

Single Heater, append letter "F" to Part No.

Double HEater, append letter "G" to Part No.

**\*\*Contact KOOLTRONIC for information.**

**ACCESSORIES AND OPTIONS\*\* (continued)**

**INTERNAL CORROSION PROTECTION:** For corrosive or other hostile environments, special coating material is applied to copper lines, coils and other parts subject to damage.

Append letter "H" to Part No.

**POWER LOSS DELAYED COMPRESSOR START:** Protects the compressor from possible damage due to harmful short cycling, by initiating an "off" period before resumption of normal operation. Generally air conditioners require several minutes off for compressor protection after power interruptions of any type. These power interruptions can include power failures, opening of interlocked access doors, and cases where a thermostat activates the compressor in less than a few minutes. This option is particularly recommended for applications where frequent, brief power failures occur, interlocked cabinet doors are utilized, or where the cabinet internal loads fluctuate across a wide range.

Append letter "Y" to Part No.

**SPECIAL PAINT FINISHES\*\***

**PAINTED METAL GRILLE\*\***

Append letter "Z" to Part No.

**CUSTOMER-INSTALLED OPTIONS:**

**FILTER RECOATING ADHESIVE:** This compound is a superior product for recoating filters after washing. The adhesives penetrate dirt layers to keep the filter surface tacky for longer effective performance between washings. Part No. A-16.

**REPLACEMENT FILTERS:** All KOOLTRONIC filters consist of a multi-layer grid of sturdy corrugated aluminum, securely held in a one-piece aluminum frame. Filters are required wherever air is drawn into an electronics enclosure or related cooling equipment to keep internal parts as clean as possible.

A non-drying adhesive coating traps a high percentage of particulate matter. These filters are reuseable, they may be washed and recoated with the appropriate filter recoating adhesive. Replacements are available for those which become damaged or otherwise non-serviceable.

Part No. 9622F

**\*\*Contact KOOLTRONIC for information.**

**HOW TO ORDER**

Specify model number. NOTE: Accessories and Options may affect model number, contact KOOLTRONIC for information.

*For assistance in model selection, refer to the Air Conditioner Sizing and Selection Guide, contact KOOLTRONIC, or use one of our design aid software programs, available FREE.*

**CALL 1-800-321-KOOL (5665)  
or FAX 609-466-1114**

**POPULAR MODELS ARE  
STOCKED AND READY TO SHIP**