

These units are discontinued, and this information is presented for reference purposes only.
Recommended replacement: See *Guardian/GuardianX* or *SlimKool Series* or current *TrimLine Series*.



**NEMA
TYPE 12 & 3R
MAINTAINED**



DISCONTINUED

TECHNICAL DATA

Model	NEMA Rating	BTU/H Capacity	95/95	Ambient			**	Approx. Weight (lbs.)
			Rating BTU/H	Temp. °F Max./Min.	Volts	Hz	Running Amps	
KA3C6RTL	3R&12	6000	4600	120/0	115/100	60/50	13.5/13.3	131
K23C6RTL	3R&12	6000	4600	120/0	230/200	60/50	6.0/5.7	131
KA3C12RTL	3R&12	12000	7900	120/0	115/100	60/50	18.0/19.0	140
K2A3C12RTL	3R&12	12000	7900	120/0	230/200	60	9.0/9.2	140

** Rating shown is for operation at maximum ambient temperature.

STANDARD FEATURES

- CFC-Free Refrigerant
- Digital Temperature Display
- EMI/RFI Suppressor
- Filter
- Head Pressure Control
- Low Ambient Kit
- Low Temperature Control Thermostat
- NEMA 12 & 3R Ratings Maintained (UL50)
- Painted Metal Grille
- UL/CUL Listed

ACCESSORIES AND OPTIONS

- Enclosure Heater
- Filter Recoating Adhesive
- Internal Corrosion Protection
- Lifting Eyes
- Low Airflow Detector Remote Thermostat Relay
- Replacement Filters
- Short Cycle Protector Special controls or indicators Special materials or finishes Special motors, line cords or connectors
- Stainless or Aluminum cabinet
- Temperature Alarm



PERFORMANCE

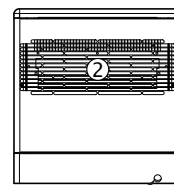
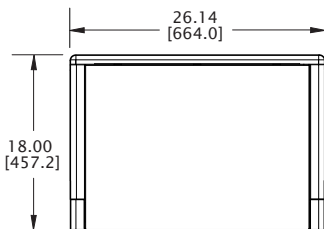
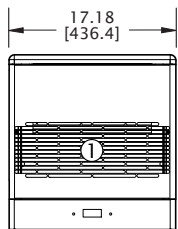
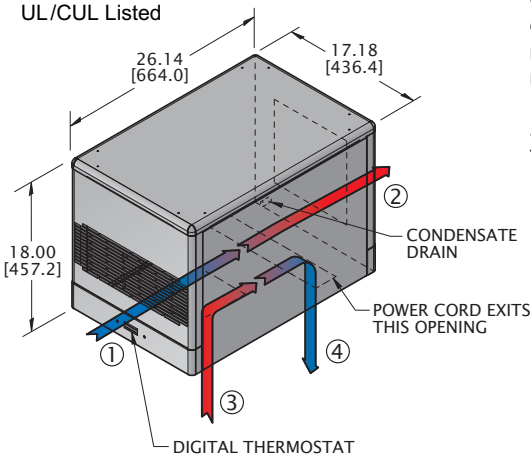
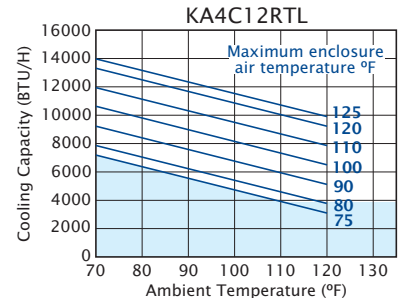
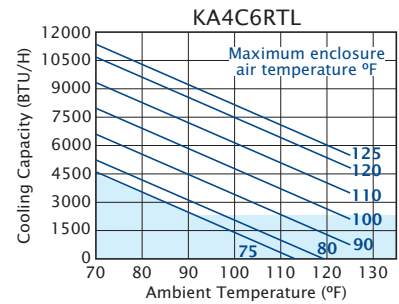

.625 [15.8] DIA. DRAIN

- ① FILTERED CONDENSER AIR INLET (Ambient Air In)
- ② CONDENSER OUTLET (Warm Ambient Air Out)
- ③ WARM AIR RETURN FROM ENCLOSURE
- ④ COOL AIR OUTLET TO ENCLOSURE

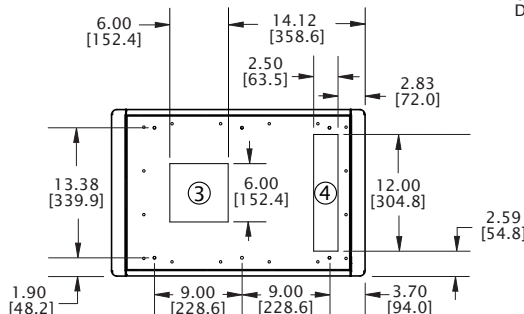

Many popular units are available as 3D solid models for customer system integration. Please contact Kooltronic for details.

Find additional information on this model at kooltronic.com, or use the Technical Documents QR code below.

Technical Documents



Dimensions, inches [mm], are for reference only and subject to change.

rtd.qxd (12/21) CDR:(20369)

DESCRIPTION

At last - air conditioners designed specifically for cooling electronic enclosures that can be used for both indoor and outdoor applications right out of the box! No more bulky unattractive weather hoods... No more worries over what options to specify for outdoor applications.

Expertly designed and crafted, the **ADVANTAGE Series** boasts a stylish appearance with rounded edges, no visible hardware and a textured baked powder finish to blend easily with contemporary enclosure designs.

Servicability has been made easier by incorporating a "knock-down" sheetmetal design which provides quick access to internal components.

Standard features include heavy duty galvanized steel construction with baked-on powder paint, environmentally friendly refrigerants, thermostatic low temperature control and EMI/RFI Suppressor. These top-mounted air conditioners are available in capacities from 3,000 to 12,000 BTU/H.

KOOLTRONIC also designs and manufactures a variety of Air Conditioners to meet *unique* specifications. We invite your inquiries about our modification and custom-design capabilities.

STANDARD FEATURES

CLOSED-LOOP COOLING: The enclosure interior airflow system is isolated from the ambient airflow system. Ambient air can not invade the cool, dehumidified sensitive component compartment.

RUGGED CONSTRUCTION: Precision-engineered heavy gauge steel construction of all cabinets and blowers insures Air Conditioners will stand up under tough applications.

BLOWERS: All centrifugal blowers are Kooltronic-designed and built, to provide optimum airflow and pressure for each Air Conditioner design.

TEXTURED BAKED POWDER FINISH: Durable, baked-on textured beige powder finish is standard. Other finishes are available.

POWER: Available in 115 VAC, 60 Hz or 50/60 switchable and 230 VAC, 50 Hz or 60 Hz.

REFRIGERANT: CFC-free Refrigerant is used in all **Advantage Series Top-Mount** Air Conditioners. (Existing units using R22 Refrigerant will continue to be serviced until December 31, 2019).

FILTERS: Multi-layer grid of sturdy, corrugated aluminum in an aluminum frame. May be reused after washing off accumulations and spraying with A-16 Recoating Adhesive.

CONDENSATE DISPOSAL: Condensate drain fitting and hose are included.

LOW AMBIENT KIT: Maintains sufficient operating pressures when ambient temperatures drop below 50°F [10°C]. Includes a compressor heater and pressure actuated condenser blower cycling control.

LOW TEMPERATURE CONTROL: Thermostatic Low Temperature Control prevents over-cooling and provides energy-efficient operation.

EMI/RFI SUPPRESSOR: EMI/RFI Suppressor minimizes transient line spikes during on/off cycling.

POWER CORD: All models have six foot [1.8m] SJT-type 3-wire power cords with appropriate plugs.

INSULATION: All cold components, lines and the evaporator compartment are insulated with high-performance insulation for maximum efficiency.

GASKETING: All units are fully gasketed for tight, leakproof installation, in compliance with the NEMA 3R Enclosure Rating.

QUALITY ASSURANCE: Refrigeration system components are kept sealed until charged with refrigerant; all brazed joints are thoroughly leak-tested; each unit is functionally tested before shipment.

INSTALLATION: Detailed Installation and Operator's Manual, with drawings, mounting plan and spare parts list is included with each unit.

UL/CUL LISTED: All **Advantage Series Top-Mount** models are **UL/CUL Listed**.

ACCESSORIES AND OPTIONS**

FACTORY-INSTALLED OPTIONS:

ALUMINUM CABINET: Where light weight and/or compatibility with appearance of Aluminum Enclosures are required. Unpainted Type 5052 is standard. Other types and ultra-violet-resistant baked powder finish are available.

Append letter "A" to Part No. (5052 Unpainted)

COOLING EFFECT DETECTOR: A thermostat is mounted inside the cabinet and attached to a sensor in the warm air return. When the air temperature increases to the set point, a signal is sent to a terminal block. User-installed wiring from the terminal block to local and/or remote warning devices (*light, bell, siren, etc.*) can be for normally open or closed operation.

Append letter "B" to Part No.

ENCLOSURE HEATER: 120V or 240V fin strip heater, installed singly or ganged, used to maintain desired internal enclosure temperature, under cold operating conditions.

Single Heater, append letter "F" to Part No.

Double Heater, append letter "G" to Part No.

INTERNAL CORROSION PROTECTION: For corrosive or other hostile environments, special coating material is applied to copper lines, coils and other parts subject to damage. Also see **Stainless Steel Cabinet** or **Integrity NEMA 4/4X Air Conditioners**.

Append letter "H" to Part No.

****Contact KOOLTRONIC for information.**

ACCESSORIES AND OPTIONS (continued)**

LIFTING EYES: Heavy-gauge steel lifting eyes, attached to the side panels, assist in positioning units.

Append letter "K" to Part No.

LOW AIRFLOW DETECTOR: Similar to the Airflow Switch shown in the Blower Accessories Section, the switch is installed in a suitable location in the Air Conditioner to detect loss of airflow, and sends a signal to a terminal block, through which user-installed wiring and warning devices are activated.

Append letter "M" to Part No.

REMOTE THERMOSTAT RELAY: Used only with a user-installed remote thermostat, the 24VAC relay can be used with a lead lag control (see below) for the sequential operation of two units or with a single unit. An external terminal strip is provided for field interconnection. Note: A factory installed thermostat is not provided with this option.

SHORT CYCLE PROTECTOR: Protects the compressor from possible damage due to harmful short cycling, by initiating an "off" period before resumption of normal operation. Generally air conditioners require several minutes off for compressor protection after power interruptions of any type. These power interruptions can include power failures, opening of interlocked access doors, and cases where a thermostat activates the compressor in less than a few minutes. This option is particularly recommended for applications where frequent, brief power failures occur, interlocked cabinet doors are utilized, or where the cabinet internal loads fluctuate across a wide range.

Append letter "Y" to Part No.

SPECIAL CONTROLS OR INDICATORS**

SPECIAL MATERIALS OR FINISHES**

SPECIAL MOTORS, LINE CORDS OR CONNECTORS**

STAINLESS STEEL CABINET: For applications in corrosive or other hostile environments such as those requiring Internal Corrosion Resistant Coatings, especially where chemical/moisture combinations are present.

Append letter "V" to Part No. (304-2B Unpainted)

CUSTOMER-INSTALLED OPTIONS

FILTER RECOATING ADHESIVE: This compound is a superior product for recoating filters after washing. The adhesives penetrate dirt layers to keep the filter surface tacky for longer effective performance between washings. Part No. A-16.

REPLACEMENT FILTERS: All KOOLTRONIC filters consist of a multi-layer grid of sturdy corrugated aluminum, securely held in a one-piece aluminum frame. Filters are required wherever air is drawn into an electronics enclosure or related cooling equipment to keep internal parts as clean as possible.

A non-drying adhesive coating traps a high percentage of particulate matter. These filters are reuseable, they may be washed and recoated with the appropriate filter recoating adhesive. Replacements are available for those which become damaged or otherwise non-serviceable.

Part No. 10871F (16.63" x 10.13" x 0.50" [422mm x 257mm x 13mm])

****Contact KOOLTRONIC for information.**

HOW TO ORDER

Specify model number. NOTE: Accessories and Options may affect model number, contact KOOLTRONIC for information.

For assistance in model selection, refer to the Air Conditioner Sizing and Selection Guide, contact KOOLTRONIC, or use one of our design aid software programs, available FREE.

**CALL 1-800-321-KOOL (5665)
or FAX 609-466-1114**

**POPULAR MODELS ARE
STOCKED AND READY TO SHIP**