

THIS DOCUMENT IS THE PROPERTY OF KOOLTRONIC, INC. AND CONTAINS PROPRIETARY AND CONFIDENTIAL INFORMATION WHICH MUST NOT BE DUPLICATED, USED OR DISCLOSED OTHER THAN AS EXPRESSLY AUTHORIZED BY KOOLTRONIC, INC.

REVISIONS				
SYM	NOTICE	DESCRIPTION	DATE	APPROVED
-	ER 94/224	NEW DRAWING RELEASE	8/17/94	MJH

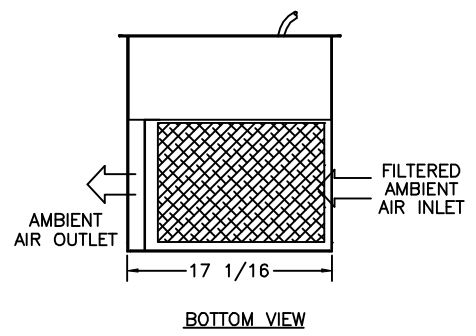
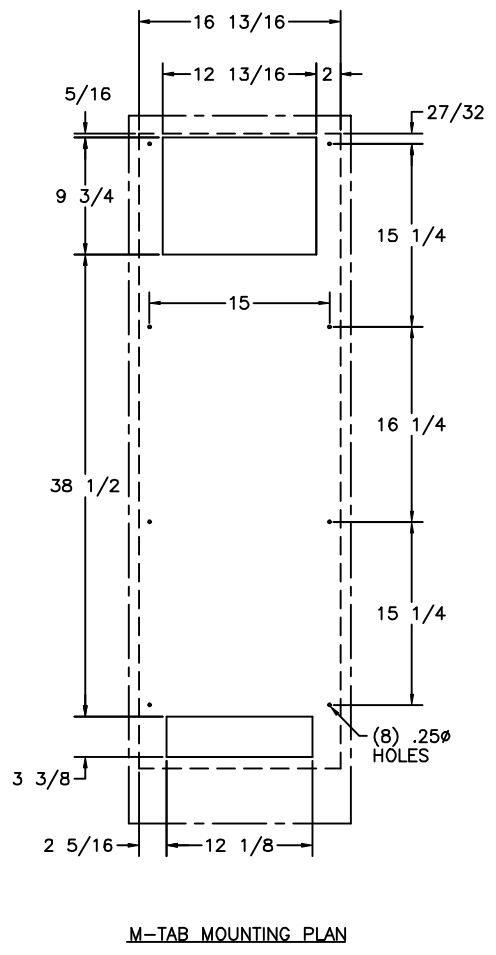
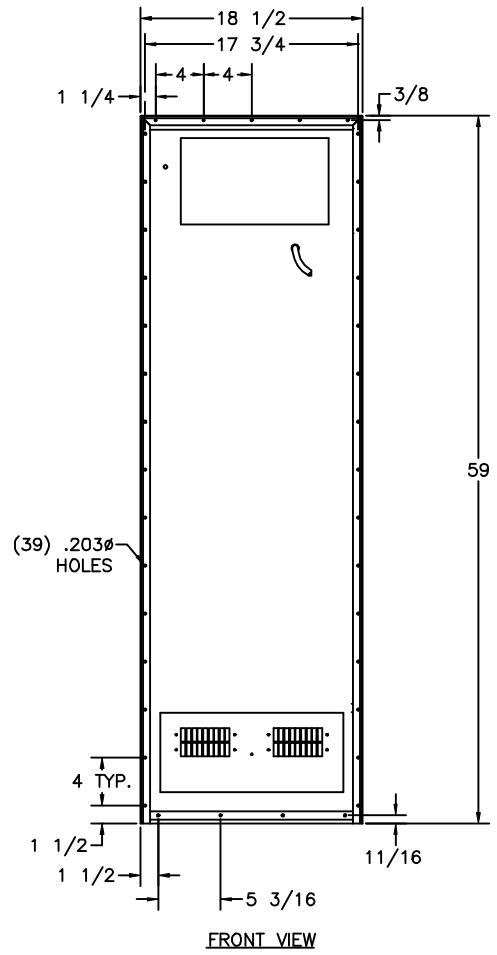
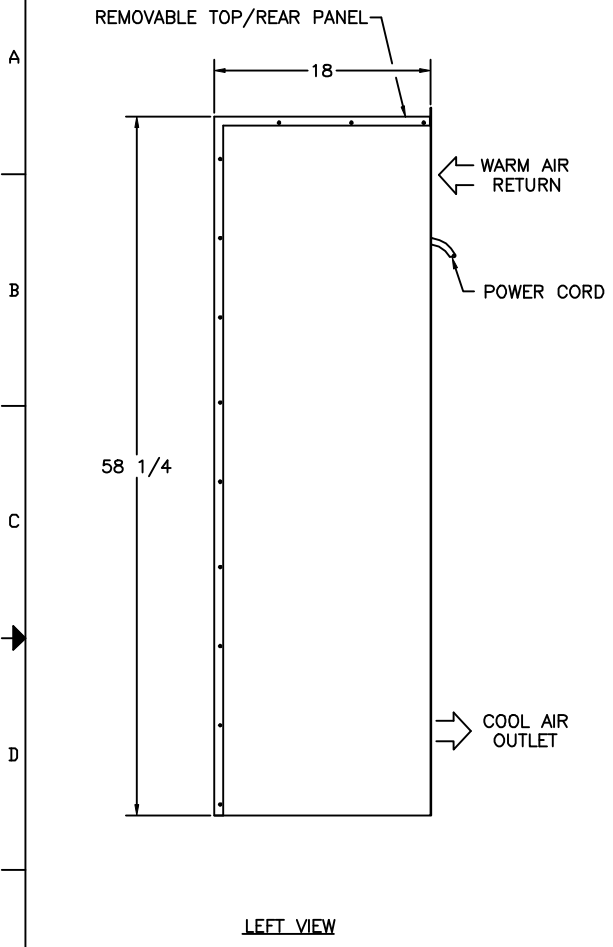

ALL DIMENSIONS ARE IN INCHES. DIMENSIONS DESIGNATED MM ARE IN MILLIMETERS.			
UNLESS OTHERWISE SPECIFIED TOLERANCES NON-ACCUMULATIVE		DRAWN <i>M. J. H.</i>	DATE 8/17/94
TOL. ON	INCHES	MM	CHECKED
.XX	± .02	±	ENG.
.XXX	± .010	±	MFG. ENG.
ANGULAR	± 1/2°		
MATERIAL			
UNIT KNHX59	APPROVED		

KOOLTRONIC, INC.
HOPEWELL, NJ VENTURA, CA USA

TITLE
**GENERAL ARRANGEMENT
NEMA4 HEAT EXCHANGER**

CODE IDENT. NO. 06223	SIZE C	DWG. NO. 604559-00-01	REV -
SCALE 1/8=1	CAD. REF. GA000155	SHEET 1 OF 1	